

**ASME PCC-1–2013**  
(Revision of ASME PCC-1–2010)

# **Guidelines for Pressure Boundary Bolted Flange Joint Assembly**

---

**AN AMERICAN NATIONAL STANDARD**



**The American Society of  
Mechanical Engineers**

INTENTIONALLY LEFT BLANK

**ASME PCC-1–2013**  
(Revision of ASME PCC-1–2010)

# **Guidelines for Pressure Boundary Bolted Flange Joint Assembly**

---

**AN AMERICAN NATIONAL STANDARD**



**The American Society of  
Mechanical Engineers**

Two Park Avenue • New York, NY • 10016 USA

Date of Issuance: November 12, 2013

This Standard will be revised when the Society approves the issuance of a new edition.

ASME issues written replies to inquiries concerning interpretations of technical aspects of this document. Interpretations are published on the ASME Web site under the Committee Pages at <http://cstools.asme.org/> as they are issued.

Errata to codes and standards may be posted on the ASME Web site under the Committee Pages to provide corrections to incorrectly published items, or to correct typographical or grammatical errors in codes and standards. Such errata shall be used on the date posted.

The Committee Pages can be found at <http://cstools.asme.org/>. There is an option available to automatically receive an e-mail notification when errata are posted to a particular code or standard. This option can be found on the appropriate Committee Page after selecting “Errata” in the “Publication Information” section.

ASME is the registered trademark of The American Society of Mechanical Engineers.

This code or standard was developed under procedures accredited as meeting the criteria for American National Standards. The Standards Committee that approved the code or standard was balanced to assure that individuals from competent and concerned interests have had an opportunity to participate. The proposed code or standard was made available for public review and comment that provides an opportunity for additional public input from industry, academia, regulatory agencies, and the public-at-large.

ASME does not “approve,” “rate,” or “endorse” any item, construction, proprietary device, or activity.

ASME does not take any position with respect to the validity of any patent rights asserted in connection with any items mentioned in this document, and does not undertake to insure anyone utilizing a standard against liability for infringement of any applicable letters patent, nor assumes any such liability. Users of a code or standard are expressly advised that determination of the validity of any such patent rights, and the risk of infringement of such rights, is entirely their own responsibility.

Participation by federal agency representative(s) or person(s) affiliated with industry is not to be interpreted as government or industry endorsement of this code or standard.

ASME accepts responsibility for only those interpretations of this document issued in accordance with the established ASME procedures and policies, which precludes the issuance of interpretations by individuals.

No part of this document may be reproduced in any form,  
in an electronic retrieval system or otherwise,  
without the prior written permission of the publisher.

The American Society of Mechanical Engineers  
Two Park Avenue, New York, NY 10016-5990

Copyright © 2013 by  
THE AMERICAN SOCIETY OF MECHANICAL ENGINEERS  
All rights reserved  
Printed in U.S.A.

# CONTENTS

Foreword .....		v
Committee Roster .....		vi
<b>1</b>	<b>Scope</b> .....	1
<b>2</b>	<b>Introduction</b> .....	1
<b>3</b>	<b>Training and Qualification of Bolted Joint Assembly Personnel</b> .....	1
<b>4</b>	<b>Cleaning and Examination of Flange and Fastener Contact Surfaces</b> .....	1
<b>5</b>	<b>Alignment of Flanged Joints</b> .....	2
<b>6</b>	<b>Installation of Gasket</b> .....	2
<b>7</b>	<b>Lubrication of “Working” Surfaces</b> .....	5
<b>8</b>	<b>Installation of Bolts</b> .....	5
<b>9</b>	<b>Numbering of Bolts</b> .....	6
<b>10</b>	<b>Tightening of Bolts</b> .....	6
<b>11</b>	<b>Tightening Sequence</b> .....	13
<b>12</b>	<b>Target Torque Determination</b> .....	16
<b>13</b>	<b>Joint Pressure and Tightness Testing</b> .....	16
<b>14</b>	<b>Records</b> .....	16
<b>15</b>	<b>Joint Disassembly</b> .....	17
<b>16</b>	<b>References</b> .....	20
<b>Figures</b>		
1	Indicator-Type Bolting for Through-Bolted Joints .....	11
2	Indicator-Type Bolting for Studed Joints .....	12
3	Example Legacy and Alternative to Legacy Numbering Sequences for 12-Bolt Joint .....	14
4	48-Bolt Flange Bolt-Grouping Example .....	15
5	Example Short Assembly Record .....	17
6	Example Medium-Length Assembly Record .....	18
7	Example Long Assembly Record .....	19
<b>Tables</b>		
1M	Reference Values for Calculating Target Torque Values for Low-Alloy Steel Bolting Based on Target Prestress of 345 MPa (Root Area) (SI Units) .....	3
1	Reference Values for Calculating Target Torque Values for Low-Alloy Steel Bolting Based on Target Prestress of 50 ksi (Root Area) (U.S. Customary Units) .....	4
2	Torque Increments for Legacy Cross-Pattern Tightening Using a Single Tool ....	7
3	Recommended Tool, Tightening Method, and Load-Control Technique Selection Based on Service Applications .....	7
4	Legacy Cross-Pattern Tightening Sequence and Bolt-Numbering System When Using a Single Tool .....	8
4.1	Alternative to Legacy Cross-Pattern Tightening Sequence and Bolt- Numbering System When Using a Single Tool .....	9

**Appendices**

A	Training and Qualification of Bolted Joint Assembly Personnel .....	23
B	Description of Common Terms .....	39
C	Recommended Gasket Contact Surface Finish for Various Gasket Types .....	41
D	Guidelines for Allowable Gasket Contact Surface Flatness and Defect Depth .....	42
E	Flange Joint Alignment Guidelines .....	48
F	Alternatives to Legacy Tightening Sequence/Pattern .....	51
G	Use of Contractors Specializing in Bolting Services .....	65
H	Bolt Root and Tensile Stress Areas .....	66
I	Interaction During Tightening .....	67
J	Calculation of Target Torque .....	68
K	Nut Factor Calculation of Target Torque .....	69
L	ASME B16.5 Flange Bolting Information .....	70
M	Washer Usage Guidance and Purchase Specification for Through-Hardened Washers .....	71
N	Definitions, Commentary, and Guidelines on the Reuse of Bolts .....	76
O	Assembly Bolt Stress Determination .....	78
P	Guidance on Troubleshooting Flanged Joint Leakage Incidents .....	90

# FOREWORD

ASME formed an Ad Hoc Task Group on Post Construction in 1993 in response to an increased need for recognized and generally accepted engineering standards for the inspection and maintenance of pressure equipment after it has been placed in service. At the recommendation of this Task Group, the Board on Pressure Technology Codes and Standards (BPTCS) formed the Post Construction Committee (PCC) in 1995. The scope of this committee was to develop and maintain standards addressing common issues and technologies related to post-construction activities and to work with other consensus committees in the development of separate, product-specific codes and standards addressing issues encountered after initial construction for equipment and piping covered by Pressure Technology Codes and Standards. The BPTCS covers non-nuclear boilers, pressure vessels (including heat exchangers), piping and piping components, pipelines, and storage tanks.

The PCC selects standards to be developed based on identified needs and the availability of volunteers. The PCC formed the Subcommittee on Inspection Planning and the Subcommittee on Flaw Evaluation in 1995. In 1998, a Task Group under the PCC began preparation of Guidelines for Pressure Boundary Bolted Flange Joint Assembly and in 1999 the Subcommittee on Repair and Testing was formed. Other topics are under consideration and may possibly be developed into future guideline documents.

The subcommittees were charged with preparing standards dealing with several aspects of the in-service inspection and maintenance of pressure equipment and piping. *Guidelines for Pressure Boundary Bolted Flange Joint Assembly* (PCC-1) provides guidance and is applicable to both new and in-service bolted flange joint assemblies. The *Inspection Planning Using Risk-Based Methods* Standard (PCC-3) provides guidance on the preparation of a risk-based inspection plan. Imperfections found at any stage of assembly, installation, inspection, operation, or maintenance are then evaluated, when appropriate, using the procedures provided in the *Fitness-For-Service* Standard (API 579-1/ASME FFS-1). If it is determined that repairs are required, guidance on repair procedures is provided in the appropriate portion of the *Repair of Pressure Equipment and Piping* Standard (PCC-2). To provide all stakeholders involved in pressure equipment with a guide to identify publications related to pressure equipment integrity, a *Guide to Life Cycle Management of Pressure Equipment Integrity* has been prepared (PTB-2).

None of these documents are Codes. They provide recognized and generally accepted good practices that may be used in conjunction with Post-Construction Codes, such as API 510, API 570, and NB-23, and with jurisdictional requirements.

The first edition of ASME PCC-1, *Guidelines for Pressure Boundary Bolted Flange Joint Assembly*, was approved for publication in 2000. The 2010 revision was approved by ANSI as an American National Standard on January 14, 2010. This 2013 revision includes many updates and a major new Appendix A titled "Training and Qualification of Bolted Joint Assembly Personnel" and was approved by ANSI as an American National Standard on August 12, 2013.

# ASME PRESSURE TECHNOLOGY POST CONSTRUCTION COMMITTEE

(The following is the roster of the Committee at the time of approval of this Standard.)

## STANDARDS COMMITTEE OFFICERS

**C. R. Leonard**, *Chair*  
**D. Peters**, *Vice Chair*  
**S. J. Rossi**, *Secretary*

## STANDARDS COMMITTEE PERSONNEL

<b>J. E. Batey</b> , The Dow Chemical Co.	<b>J. R. Payne</b> , JPAC, Inc.
<b>C. Becht IV</b> , Becht Engineering Co., Inc.	<b>D. Peters</b> , Structural Integrity Associates
<b>D. L. Berger</b> , PPL Generation LLC	<b>J. T. Reynolds</b> , Intertek Moody
<b>W. Brown</b> , Integrity Engineering Solutions	<b>S. C. Roberts</b> , Shell Global Solutions (U.S.), Inc.
<b>P. N. Chaku</b> , Lummus Technology, Inc.	<b>C. D. Rodery</b> , BP North American Products, Inc.
<b>E. W. Hayman</b> , Consultant	<b>S. J. Rossi</b> , The American Society of Mechanical Engineers
<b>W. J. Koves</b> , Pi Engineering Software, Inc.	<b>C. W. Rowley</b> , The Wesley Corp.
<b>D. A. Lang</b> , FM Global	<b>J. Taagepera</b> , Chevron Energy Technology Co.
<b>D. E. Lay</b> , Hytorc	<b>K. Oyamada</b> , Delegate
<b>C. R. Leonard</b> , Life Cycle Engineering	<b>T. Tahara</b> , Delegate
<b>K. Mokhtarian</b> , Consultant	<b>C. D. Cowfer</b> , <i>Contributing Member</i> , Cowfer Consulting
<b>C. C. Neely</b> , Becht Engineering Co., Inc.	<b>E. Michalopoulos</b> , <i>Contributing Member</i> , Ministry of Economics of Greece
<b>T. M. Parks</b> , The National Board of Boiler and Pressure Vessel Inspectors	<b>J. R. Sims, Jr.</b> , <i>Contributing Member</i> , Becht Engineering Co., Inc.

## POST CONSTRUCTION SUBCOMMITTEE ON FLANGE JOINT ASSEMBLY (PCC)

<b>C. C. Neely</b> , <i>Chair</i> , Becht Engineering Co., Inc.	<b>G. Milne</b> , Flexitallic, Ltd.
<b>B. J. Barron</b> , Newport News Shipbuilding	<b>J. R. Payne</b> , JPAC, Inc.
<b>W. Brown</b> , Integrity Engineering Solutions	<b>C. D. Rodery</b> , BP North American Products, Inc.
<b>E. W. Hayman</b> , Consultant	<b>J. Waterland</b> , VSP Technologies
<b>D. E. Lay</b> , Hytorc	



# GUIDELINES FOR PRESSURE BOUNDARY BOLTED FLANGE JOINT ASSEMBLY

## 1 SCOPE

The bolted flange joint assembly (BFJA) guidelines described in this document apply principally to pressure-boundary flanged joints with ring-type gaskets that are entirely within the circle enclosed by the bolt holes and with no contact outside this circle.<sup>1</sup> These guidelines may be selectively applied to other joint geometries. By selection of those features suitable to the specific service or need, these guidelines may be used to develop effective joint assembly procedures for the broad range of sizes and service conditions normally encountered in industry.

Users are cautioned that the guidelines contained in ASME PCC-1 have been developed generically and are recommended for general applications. They may not necessarily be suitable for all applications. Precautionary considerations are provided in some cases but should not be considered as all inclusive. Sound engineering practices and judgment should be used to determine the applicability of a specific method or part of a method to a specific application. Each joint assembly procedure should be subject to an appropriate review by qualified personnel. While this Guideline covers joint assembly within the scope of ASME Pressure Technology Codes and Standards, it may be used on equipment constructed in accordance with other codes and standards.

Guidance on troubleshooting BFJAs not providing leak-tight performance is also provided in this document (see Appendix P).

## 2 INTRODUCTION

A BFJA is a complex mechanical device; therefore, BFJAs that provide leak-free service are the result of many selections/activities having been made/performed within a relatively narrow band of acceptable limits. One of the activities essential to leak-free performance is the joint assembly process. The guidelines outlined in this document cover the assembly elements essential for a high level of leak-tightness integrity of otherwise properly designed/constructed BFJAs. It is

<sup>1</sup> Rules for design of bolted flanges with ring-type gaskets are covered in Mandatory Appendix 2 of ASME Boiler and Pressure Vessel Code, Section VIII, Division 1; see also Nonmandatory Appendix S for supplementary considerations for bolted flanges that are helpful to the designer of Appendix 2 flanges.

recommended that written procedures, incorporating the features of these guidelines that are deemed suitable to the specific application under consideration, be developed for use by the joint assemblers. Alternative features and methods for specific applications may be used subject to endorsement by the user.

NOTE: Within the context of this Guideline, the term “user” includes the user and their authorized agent, as recorded in either the contract documents or in the written assembly procedures (see para. 14.1).

## 3 TRAINING AND QUALIFICATION OF BOLTED JOINT ASSEMBLY PERSONNEL

It is recommended that the user provide, or arrange to have provided, as appropriate, essential training and qualification in accordance with Appendix A of the bolted joint assembly personnel who will be expected to follow procedures developed from this Guideline.

See section F-2 of Appendix F for comments on accepting flange joint assembly procedures not currently listed in these guidelines.

The qualification of assemblers in accordance with Appendix A may be considered portable subject to the guidance in para. A-5.3.5.

## 4 CLEANING AND EXAMINATION OF FLANGE AND FASTENER CONTACT SURFACES

Before assembly is started, clean and examine flange and fastener contact surfaces as described in this section.

With one exception, remove all indications of the previous gasket installation from the gasket contact surfaces; use approved solvents and/or soft-wire brushes, if required, for cleaning to prevent surface contamination and damage to existing surface finish. Avoid using carbon steel brushes on stainless steel flanges.

The exception based on experience is residual flexible graphite that may remain in the surface finish grooves when either a flexible graphite clad or a spiral-wound gasket with flexible graphite filler is to be used as the replacement gasket.

(a) Examine the gasket contact surfaces of both mating joint flanges for compliance with recommended surface finish (see Appendix C) and for damage to surface finish such as scratches, nicks, gouges, and burrs. Indications running radially across the facing are of particular

concern. Refer to Appendix D for guidelines covering recommended limits on gasket contact surface imperfections and their locations.

(1) It is recommended that surface-finish comparator gages be available to joint assembly personnel.

(2) Report any questionable imperfections for appropriate disposition. If weld repair of imperfections is deemed to be required, see ASME PCC-2, Article 3.5 for repair considerations. Appendix C provides recommended final surface finishes.

(b) When working with problematic or critical service [see Note (1) of Table 3] flanges of large diameter with leak histories or suspect fabrication, it is recommended to check gasket contact surfaces of both joint flanges for flatness, both radially and circumferentially. This may be accomplished in some cases using a machinist's straight edge and feeler gages, but using either a securely mounted run-out/flatness gage or field machining equipment capable of providing accurate total indicator readings is recommended. Appendix D provides flatness tolerance recommendations.

If weld repair is deemed to be required to achieve the required flatness, see ASME PCC-2, Article 3.5 for repair considerations. Appendix C provides recommended final surface finishes.

(c) Examine bolt<sup>2</sup> and nut threads and washer faces of nuts for damage such as rust, corrosion, and burrs; replace/correct any damaged components. Likewise bolt/nut combinations for which the nuts will not turn freely by hand past where they will come to rest after tightening should be replaced/corrected; this includes tapped hole threads. (See ASME PCC-2, Article 3.3, which covers repair of damaged tapped hole threads.) If separate washers are scored or cupped from previous use, replace with new through-hardened washers<sup>3</sup> (surface-hardened washers are not suitable). The condition of previously used bolts/nuts has a large influence on the performance of a bolted joint assembly. The following guidelines relating to the reuse of bolts/nuts are offered for consideration:

(1) When using bolts and nuts of common grade as fasteners, the use of new bolts and nuts up to M30 (1<sup>1</sup>/<sub>8</sub> in.) diameter is recommended when bolt load-control methods such as torque or tension are deemed necessary (see Appendix N). For larger bolt diameters, it is recommended that the cost of cleaning, deburring, and reconditioning be compared to the replacement cost and considered in the assessment of critical issues of the assembly. When assessing the cost, consider that

<sup>2</sup> "Bolt" as used herein is an all-inclusive term for any type of threaded fastener that may be used in a pressure-boundary BFJA such as a bolt, stud, studbolt, cap screw, etc.

<sup>3</sup> Use of washers is optional. However, it is generally recognized that the use of through-hardened steel washers will improve the translation of torque input into consistent bolt stretch. See Appendix M for a suitable through-hardened washer specification guideline.

working with and reconditioning fasteners in the field may be more expensive than the cost of replacement and that the results of reconditioning can be unpredictable. When coated bolts are used, the remaining corrosion protection and self-lubricating functions are additional considerations with respect to continued use or replacement. See Notes (2) and (3) of Table 1M/Table 1, and paras. 7(e) and 7(f).

(2) Strong consideration should be given to replacing bolts of any size should it be found that they have been abused or nonlubricated during previous assemblies.

(3) Thread dies generally do not result in a smooth, reconditioned surface; therefore, turning bolt threads in a lathe is the preferred method to recondition costly fasteners. The process will remove thread material; therefore, the user is cautioned to ensure the tolerance limits of ASME B1.1 for the original class of fit specified are not exceeded. Any fastener with thread dimensions less than the minimum major diameter or the minimum pitch diameter should be replaced.

(4) Nuts are generally replaced rather than reconditioned.

Appendix N provides supplementary information on the bolt reuse topic.

(d) Examine nut-bearing or washer-bearing surfaces of flanges for coating, scores, burrs, visual evidence of out-of-squareness (indicated by uneven wear), etc. Coatings over approximately 0.13 mm (0.005 in.) thick should either be removed or reduced in thickness; remove all coating for critical joints. Roughness, gouges, and protrusions should be removed from these surfaces. On severely damaged flanges, machining this area may be required, in which case the minimum acceptable residual flange thickness must be considered. The use of through-hardened, flat washers<sup>4</sup> may be appropriate to provide smooth and square nut-bearing surfaces.

## 5 ALIGNMENT OF FLANGED JOINTS

Proper alignment of all joint members is the essential element of flange joint assembly. It results in maximum sealing surface contact, maximum opportunity for uniform and design-level gasket loading, and reduced friction between the nut and the flange. Guidelines for aligning flanged joints are provided in Appendix E.

## 6 INSTALLATION OF GASKET

Place a new gasket in position after determining the absence of (or having made correction for) unacceptable

<sup>4</sup> Flat washers protect the nut-contact surface of the flange from damage and provide a smooth and low-friction turning surface for the nuts. These are important considerations when torquing methods (either manual or hydraulic) are used for bolt tightening. Flat washers also promote improved load distribution. See Appendix M for a suitable through-hardened washer purchase specification guideline.

**Table 1M Reference Values for Calculating Target Torque Values for Low-Alloy Steel Bolting Based on Target Prestress of 345 MPa (Root Area) (SI Units)**  
(See section 12 for instructions on how to adjust torque values in this table.)

Basic Thread Designation	Target Torque, N-m	
	Noncoated Bolts [Note (1)]	Coated Bolts [Notes (1), (2), and (3)]
M14-2	110	85
M16-2	160	130
M20-2.5	350	250
M24-3	550	450
M27-3	800	650
M30-3	1 150	900
M33-3	1 550	1 200
M36-3	2 050	1 600
M39-3	2 650	2 050
M42-3	3 350	2 550
M45-3	4 200	3 200
M48-3	5 100	3 900
M52-3	6 600	5 000
M56-3	8 200	6 300
M64-3	12 400	9 400
M70-3	16 100	12 200
M76-3	20 900	15 800
M82-3	26 400	20 000
M90-3	35 100	26 500
M95-3	41 600	31 500
M100-3	48 500	36 700

## GENERAL NOTES:

- The values shown are based on a Target Prestress of 345 MPa (root area). See section 12 (Target Torque Determination). The root areas are based on coarse-thread series for sizes M27 and smaller, and 3-mm pitch thread series for sizes M30 and larger.
- There are many ways of calculating Target Torque values for bolted pressure joints. The basis for the torque values in Table 1M are described in the Notes below. When conditions vary, such as different bolt materials or different coatings, from those considered in this table, refer to Appendix K, or optionally to Appendix J, of these guidelines to compute appropriate torque values.

## NOTES:

- The tabulated Target Torque values are based on “working” surfaces that comply with section 4 (Cleaning and Examination of Flange and Fastener Contact Surfaces) and section 7 (Lubrication of “Working” Surfaces). The Target Torque values were computed using nut factors selected to achieve a Target Prestress of 345 MPa. The torques were adjusted based on industry experience and verified by bolt elongation measurements.
- The coating on coated bolts is polyimide/amide and is considered to be the sole source of “working” surface lubrication; the application of a lubricant to the coated surfaces can result in a considerable reduction in the assumed coefficient of friction of approximately 0.12. (See Appendix K for equivalent nut factor.)
- Coated torque values apply only for initial tightening of new, coated bolts using the torque-increment rounds shown in Table 2. For second and subsequent tightening by torquing methods, use of lubricants and torque values as specified for noncoated bolts is recommended.

**Table 1 Reference Values for Calculating Target Torque Values for Low-Alloy Steel Bolting Based on Target Prestress of 50 ksi (Root Area) (U.S. Customary Units)**

*(See section 12 for instructions on how to adjust torque values in this table.)*

Nominal Bolt Size, in.	Target Torque, ft-lb	
	Noncoated Bolts [Note (1)]	Coated Bolts [Notes (1), (2), and (3)]
$\frac{1}{2}$	60	45
$\frac{5}{8}$	120	90
$\frac{3}{4}$	210	160
$\frac{7}{8}$	350	250
1	500	400
$1\frac{1}{8}$	750	550
$1\frac{1}{4}$	1,050	800
$1\frac{3}{8}$	1,400	1,050
$1\frac{1}{2}$	1,800	1,400
$1\frac{5}{8}$	2,350	1,800
$1\frac{3}{4}$	2,950	2,300
$1\frac{7}{8}$	3,650	2,800
2	4,500	3,400
$2\frac{1}{4}$	6,500	4,900
$2\frac{1}{2}$	9,000	6,800
$2\frac{3}{4}$	12,000	9,100
3	15,700	11,900
$3\frac{1}{4}$	20,100	15,300
$3\frac{1}{2}$	25,300	19,100
$3\frac{3}{4}$	31,200	23,600
4	38,000	28,800

GENERAL NOTES:

- The values shown are based on a Target Prestress of 50 ksi (root area). See section 12 (Target Torque Determination). The root areas are based on coarse-thread series for sizes 1 in. and smaller, and 8-pitch thread series for sizes  $1\frac{1}{8}$  in. and larger.
- There are many ways of calculating Target Torque values for bolted pressure joints. The basis for the torque values in Table 1 are described in the Notes below. When conditions vary, such as different bolt materials or different coatings, from those considered in this table, refer to Appendix K, or optionally to Appendix J, of these guidelines to compute appropriate torque values.

NOTES:

- The tabulated Target Torque values are based on “working” surfaces that comply with section 4 (Cleaning and Examination of Flange and Fastener Contact Surfaces) and section 7 (Lubrication of “Working” Surfaces). The Target Torque values were computed using nut factors selected to achieve a Target Prestress of 50 ksi. The torques were adjusted based on industry experience and verified by bolt elongation measurements.
- The coating on coated bolts is polyimide/amide and is considered to be the sole source of “working” surface lubrication; the application of a lubricant to the coated surfaces can result in a considerable reduction in the assumed coefficient of friction of approximately 0.12. (See Appendix K for equivalent nut factor.)
- Coated torque values apply only for initial tightening of new, coated bolts using the torque-increment rounds shown in Table 2. For second and subsequent tightening by torquing methods, use of lubricants and torque values as specified for noncoated bolts is recommended.

gasket sealing surface imperfections and flatness tolerance deviations, as well as joint alignment considerations (see Appendices D and E).

Reuse of a gasket is not recommended. However, the substrates of grooved metal gaskets with facing layers may be reused after having been reconditioned and refaced in a manner consistent with the original product specification. The reinstallation of gaskets so refurbished is not considered gasket reuse since the sealing performance of the gasket has been restored. For other gasket types, experience has clearly shown that only a new gasket will reliably provide the necessary plastic deformation and elastic recovery characteristics essential to achieve an effective seal. Visual or physical inspection of a used gasket for apparent damage is not sufficient to detect such sealing surface factors as work-hardening, brittleness, or the effects of heat or interaction with the service fluid.

(a) Verify that the gasket complies with the dimensional (O.D., I.D., thickness) and material specifications.

(b) Position the gasket to be concentric with the flange I.D., taking suitable measures to ensure that it is adequately supported during the positioning process. No portion of the gasket should project into the flow path.

(c) Ensure that the gasket will remain in place during the joint assembly process; a very light dusting of spray adhesive on the gasket (not the flange) may be used. Particular care should be taken to avoid adhesive chemistry that is incompatible with the process fluid or could result in stress corrosion cracking or pitting of the flange surfaces. *Do not use tape strips radially across the gasket to hold it in position. Do not use grease.*

## 7 LUBRICATION OF “WORKING” SURFACES<sup>5</sup>

Lubrication reduces the coefficient of friction and results in less required torque to achieve a given tension, improves the consistency of achieved load from bolt to bolt within the joint, and aids in the subsequent disassembly of the fasteners.

The reference torque values for new, coated bolts/nuts shown in Table 1M/Table 1 do not consider lubrication other than that provided by the bolt/nut coating [see Note (2) of Table 1M/Table 1]. When reusing coated bolts or if lubricant is applied to new or reused coated bolts, the Nut Factor will change and therefore the torque values should be adjusted accordingly (refer to Appendix K).

(a) Ensure that the lubricant is chemically compatible with the bolt/nut/washer materials and the process fluid. Particular care should be taken to avoid lubricant chemistry that could contribute to stress corrosion cracking, galvanic corrosion, oxygen auto-ignition, etc.

<sup>5</sup> The term “working” surfaces refers to those interfaces between fastener components and/or fasteners and flanges that slide past one another during tightening or loosening.

(b) Ensure that the lubricant has proven to be suitable for the expected range of service temperature(s) and anti-seize requirements.

(c) Before lubricant is applied to the bolt and nut threads, nuts must run freely by hand past where they will come to rest after tightening. If nuts will not turn freely by hand, check for cause and make necessary corrections/replacements.

(d) For noncoated bolts (see Notes to Table 1M/Table 1), apply lubricant liberally and completely to the nut contact faces and to the threads on both ends of the bolts past where the nuts will come to rest after tightening; the lubricant should be applied after the bolts are inserted through the flange bolt holes to avoid possible contamination with solid particles that could create unwanted reaction torque. Lubrication should be applied irrespective of the tightening method used.

(e) For new coated bolts and nuts (see Notes to Table 1M/Table 1), free-running nut checks as described in (c) are required. On the second and subsequent tightening operations, apply lubricant as described in (d).

(1) The reference torque values for new, coated bolts/nuts shown in Table 1M/Table 1 do not consider lubrication other than that provided by the bolt/nut coating [see Note (2) of Table 1M/Table 1]. When reusing coated bolts or if lubricant is applied to new or reused coated bolts, the Nut Factor will change and therefore the torque values should be adjusted accordingly (refer to Appendix K).

(f) While it is recognized that the inherent lubricity of new coated bolts results in less torque being required during the first tightening operation to achieve a given level of tension in the bolt (see Table 1M/Table 1), the major long-term value of coated bolts is to protect against corrosion of the exposed threads and to minimize break-out and nut-removal torque, thereby promoting ease of joint disassembly [see section 15, and Note (3) of Table 1M/Table 1].

(g) Do not apply either approved lubricant or unapproved compounds to the gasket or gasket-contact surfaces; protect against inadvertent application to these surfaces.

## 8 INSTALLATION OF BOLTS

Install bolts and nuts so they are hand-tight with the marked ends of the bolts and nuts located on the same side of the joint and facing outward to facilitate inspection; then snug up to 15 N·m (10 ft·lb) to 30 N·m (20 ft·lb), but not to exceed 20% of the Target Torque (see section 12). If nuts do not hand tighten, check for cause and make necessary corrections.

### 8.1 Bolt/Nut Specifications

Verify compliance with bolt and nut specifications [materials, diameter, length of bolts, thread pitch, and

nut thickness equal to the nominal bolt diameter (heavy hex series nuts)].

## 8.2 Bolt Lengths

Check bolts for adequate length. This length should consider the presence of washers, nut height, and required thread protrusion. Section VIII, Division 1 of the ASME Boiler and Pressure Vessel Code requires that nuts engage the threads for the full depth of the nut (see para. UG-13). The ASME B31.3, Process Piping Code, has a similar provision but considers the nut to be acceptably engaged if the lack of complete engagement is not more than one thread (see para. 335.2.3). The use of bolt tensioners requires that the threaded portion of the bolt extend at least one bolt diameter beyond the outside nut face on the tensioner side of the joint. Galvanized or coated bolts may require special tensioner puller sleeves.

**8.2.1** Excess thread protrusion can hinder joint disassembly due to corrosion, paint, or damage. A practice that facilitates joint disassembly (see section 15) is to fully engage the nut on one end (no bolt projection beyond the nut) so that all excess threads are located on the opposite end. Excess thread protrusion beyond the nut should be minimized.

**8.2.2** When the effective stretching length (“ $L_{eff}$ ,” see para. 10.2) is short,<sup>6</sup> the total initial bolt elongation ( $\Delta L$ ; see para. 10.2) resulting from the determined Target Bolt Stress (see section 12) will be a proportionately small value, thereby resulting in a significant percentage reduction in the post-assembly bolt stress due to normal gasket creep, embedment losses, and joint heat-up. The sensitivity to this occurrence should be given careful attention along with other joint considerations when selecting the level of Target Bolt Stress.

## 9 NUMBERING OF BOLTS

### 9.1 Numbering of Bolts When a Single Tool Is Used

When either the Legacy or Modified Legacy methods are used, the corresponding bolt-numbering systems are as follows:

(a) A system whereby each bolt location, starting with number 1 and continuing through  $N$ , is numbered sequentially on the flange in a clockwise manner (where  $N$  is the total number of bolts in the joint). This system was used in ASME PCC-1–2000. It has been retained (and therefore referenced as the Legacy method). The cross-pattern passes are completed using the pattern outlined in Table 4, Legacy Cross-Pattern Tightening Sequence and Bolt-Numbering System. This numbering system allows, for example, the quick identification of

<sup>6</sup> A bolt having an effective length shorter than 5 times its nominal diameter is generally considered to be “short.”

bolt number 20 in a 40-bolt flange but requires a reference table such as Table 4 for the tightening sequence during the tightening process.

(b) An alternative numbering system for the Legacy method (see Table 4.1) is designed so that the number assigned at each bolt location represents the sequential order for tightening that bolt; in other words, the cross-pattern tightening sequence is identified by the assigned bolt number and, therefore, a separate reference table is not required during the tightening process. For the purposes of joint assembly, the Table 4 and Table 4.1 numbering systems are considered equivalent.

See Appendix F for joint assembly patterns and torque-increment combinations that require less assembly effort than the Table 4 Legacy and the Table 4.1 Modified Legacy methods.

### 9.2 Numbering of Bolts When Multiple Tools Are Used

See Appendix F (Alternative Patterns #4 and #5).

## 10 TIGHTENING OF BOLTS

Using the selected tightening method/load-control technique (see para. 10.1), tighten the joint using either the torque increment rounds shown in Table 2 and either the companion Table 4 or Table 4.1 cross-pattern tightening sequences when using a single tool as described in section 11, or one of the alternative tightening procedures shown in Alternatives #1, #2, and #3 of Appendix F.

Alternatives #4 and #5 illustrate alternative group numbering systems and tightening sequences when simultaneously using multiple tools.

NOTE: When hydraulic bolt tensioners are employed, use the procedure recommended by personnel who are experienced and qualified in controlled bolting services. Guidelines on use of contractors specializing in bolting services are provided in Appendix G.

It is recognized by Nonmandatory Appendix S of the ASME Boiler and Pressure Vessel Code, Section VIII, Division 1 that the initial tightening of the bolts in a joint comprising flanges designed in accordance with Appendix 2 of that Code is a prestressing operation and that the level of required Target Bolt Prestress can vary considerably above the code tabulated design-stress value. This is an acceptable and usually required practice. Appendix S states that “. . . an initial bolt stress higher than the design value may and, in some cases, must be developed in the tightening operation, and it is the intent of this Division that such a practice is permissible, provided it includes necessary and appropriate provision to ensure against excessive flange distortion and gross crushing of the gasket.” For joints custom designed in accordance with Appendix 2, a common range of Target Bolt Prestress that is often found acceptable is around 40% to 70% of the specified minimum

**Table 2 Torque Increments for Legacy Cross-Pattern Tightening Using a Single Tool**

Step	Loading
Install	Hand tighten, then “snug up” to 15 N·m (10 ft·lb) to 30 N·m (20 ft·lb) (not to exceed 20% of Target Torque). Check flange gap around circumference for uniformity. If the gap around the circumference is not reasonably uniform, make the appropriate adjustments by selective tightening before proceeding.
Round 1	Tighten to 20% to 30% of Target Torque (see section 12). Check flange gap around circumference for uniformity. If the gap around the circumference is not reasonably uniform, make the appropriate adjustments by selective tightening/loosening before proceeding.
Round 2	Tighten to 50% to 70% of Target Torque (see section 12). Check flange gap around circumference for uniformity. If the gap around the circumference is not reasonably uniform, make the appropriate adjustments by selective tightening/loosening before proceeding.
Round 3	Tighten to 100% of Target Torque (see section 12). Check flange gap around circumference for uniformity. If the gap around the circumference is not reasonably uniform, make the appropriate adjustments by selective tightening/loosening before proceeding.
Round 4	Continue tightening the bolts, but on a circular clockwise pattern until no further nut rotation occurs at the Round 3 Target Torque value. For indicator bolting, tighten bolts until the indicator rod retraction readings for all bolts are within the specified range.
Round 5	Time permitting, wait a minimum of 4 hr and repeat Round 4; this will restore the short-term creep relaxation/embedment losses. If the flange is subjected to a subsequent test pressure higher than its rating, it may be desirable to repeat this round after the test is completed.

**Table 3 Recommended Tool, Tightening Method, and Load-Control Technique Selection Based on Service Applications**  
(See para. 10.1)

Service Applications [Note (1)]	Tools [Note (2)]	Tightening Method	Load-Control Technique
Mild Service	Manual or auxiliary-powered tools	Pattern single or multibolt tightening procedures	Consistent procedures per industry best practices or torque control
Intermediate Service	Manual or auxiliary-powered tools or torque- or tension-measuring tools	Pattern single or multibolt tightening procedures	See Note (3)
Critical Service	Torque- or tension-measuring tools	Pattern single or multibolt tightening procedures	Torque or tension control with final bolt elongation/load verification optional [Note (4)]

## NOTES:

- (1) Service Applications should be designated by the user and should consider governing design conditions (pressure, temperature, etc.), mechanical criteria (bolt diameter, flange diameter, gasket type, etc.), joint leakage history, and fluid service category.
  - (a) An example of Mild Service could include Category D Fluid Service as defined in ASME B31.3.
  - (b) An example of Intermediate Service could include Normal Fluid Service as defined in ASME B31.3.
  - (c) Examples of Critical Service could include service requirements as defined by local jurisdictional requirements [example for United States is CFR 1910.119 (OSHA PSM rule)], lethal substance service as defined in the ASME Section VIII, Division 1 Code, or Category M Fluid Service as defined in ASME B31.3.
- (2) All tools are to be regularly and properly maintained and calibrated.
- (3) It is recognized that many joints are regularly tightened using impact wrenches or manual tools with no precise load control. Experience may prove this is sufficient for certain applications, but unmeasured tightening is not recommended for intermediate service applications without careful consideration of the risks.
- (4) Where past practice with specific or similar equipment warrant or where testing/research validates, elongation and load verification may be waived.

**Table 4 Legacy Cross-Pattern Tightening Sequence and Bolt-Numbering System When Using a Single Tool**

No. of Bolts	Tightening Sequence for Cross-Pattern Passes [Note (1)]
4	1-3-2-4
8	1-5-3-7 → 2-6-4-8
12	1-7-4-10 → 2-8-5-11 → 3-9-6-12
16	1-9-5-13 → 3-11-7-15 → 2-10-6-14 → 4-12-8-16
20	1-11-6-16 → 3-13-8-18 → 5-15-10-20 → 2-12-7-17 → 4-14-9-19
24	1-13-7-19 → 4-16-10-22 → 2-14-8-20 → 5-17-11-23 → 3-15-9-21 → 6-18-12-24
28	1-15-8-22 → 4-18-11-25 → 6-20-13-27 → 2-16-9-23 → 5-19-12-26 → 7-21-14-28 ↓ 3-17-10-24
32	1-17-9-25 → 5-21-13-29 → 3-19-11-27 → 7-23-15-31 → 2-18-10-26 → 6-22-14-30 ↓ 4-20-12-28 → 8-24-16-32
36	1-2-3 → 19-20-21 → 10-11-12 → 28-29-30 → 4-5-6 → 22-23-24 → 13-14-15 ↓ 31-32-33 → 7-8-9 → 25-26-27 → 16-17-18 → 34-35-36
40	1-2-3-4 → 21-22-23-24 → 13-14-15-16 → 33-34-35-36 → 5-6-7-8 → 25-26-27-28 ↓ 17-18-19-20 → 37-38-39-40 → 9-10-11-12 → 29-30-31-32
44	1-2-3-4 → 25-26-27-28 → 13-14-15-16 → 37-38-39-40 → 5-6-7-8 → 29-30-31-32 ↓ 17-18-19-20 → 41-42-43-44 → 9-10-11-12 → 33-34-35-36 → 21-22-23-24
48	1-2-3-4 → 25-26-27-28 → 13-14-15-16 → 37-38-39-40 → 5-6-7-8 → 29-30-31-32 ↓ 17-18-19-20 → 41-42-43-44 → 9-10-11-12 → 33-34-35-36 → 21-22-23-24 → 45-46-47-48
52	1-2-3-4 → 29-30-31-32 → 13-14-15-16 → 41-42-43-44 → 5-6-7-8 → 33-34-35-36 ↓ 17-18-19-20 → 45-46-47-48 → 21-22-23-24 → 49-50-51-52 → 25-26-27-28 ↓ 9-10-11-12 → 37-38-39-40
56	1-2-3-4 → 29-30-31-32 → 13-14-15-16 → 41-42-43-44 → 21-22-23-24 → 49-50-51-52 ↓ 9-10-11-12 → 37-38-39-40 → 25-26-27-28 → 53-54-55-56 → 17-18-19-20 ↓ 45-46-47-48 → 5-6-7-8 → 33-34-35-36
60	1-2-3-4 → 29-30-31-32 → 45-46-47-48 → 13-14-15-16 → 5-6-7-8 → 37-38-39-40 ↓ 21-22-23-24 → 53-54-55-56 → 9-10-11-12 → 33-34-35-36 → 49-50-51-52 → 17-18-19-20 ↓ 41-42-43-44 → 57-58-59-60 → 25-26-27-28
64	1-2-3-4 → 33-34-35-36 → 17-18-19-20 → 49-50-51-52 → 9-10-11-12 → 41-42-43-44 ↓ 25-26-27-28 → 57-58-59-60 → 5-6-7-8 → 37-38-39-40 → 21-22-23-24 → 53-54-55-56 ↓ 13-14-15-16 → 45-46-47-48 → 29-30-31-32 → 61-62-63-64
68	1-2-3-4 → 37-38-39-40 → 21-22-23-24 → 53-54-55-56 → 9-10-11-12 → 45-46-47-48 ↓ 29-30-31-32 → 61-62-63-64 → 17-18-19-20 → 57-58-59-60 → 33-34-35-36 → 5-6-7-8 ↓ 41-42-43-44 → 13-14-15-16 → 49-50-51-52 → 25-26-27-28 → 65-66-67-68

## GENERAL NOTES:

- (a) See Table 4.1 covering an alternative to the Legacy pattern numbering system.
- (b) See Appendix F for Alternative #1 (Modified Legacy), which uses the same numbering system as the Legacy method (Table 4 or Table 4.1) but a different torque increment than that in Table 2. Alternatives #2 and #3 from Appendix F use both a different pattern than that in Table 4 or Table 4.1 and a different torque increment than that in Table 2. Compliance with the limitations of the application of these alternatives is essential.
- (c) See Appendix F for Alternatives #4 and #5 for alternative group numbering and tightening sequence when simultaneously using multiple tools.

## NOTE:

- (1) See Figs. 3 and 4 for illustrations of Legacy cross-pattern tightening sequences and bolt-numbering system when using a single tool.



**Table 4.1 Alternative to Legacy Cross-Pattern Tightening Sequence and Bolt-Numbering System  
When Using a Single Tool  
(See section 9)**

No. of Bolts	Bolt-Numbering Sequence to Be Marked Clockwise on Flange [Note (1)]
4	1, 3, 2, 4
8	1, 5, 3, 7, 2, 6, 4, 8
12	1, 9, 5, 3, 11, 7, 2, 10, 6, 4, 12, 8
16	1, 9, 5, 13, 3, 11, 7, 15, 2, 10, 6, 14, 4, 12, 8, 16
20	1, 17, 9, 5, 13, 3, 19, 11, 7, 15, 2, 18, 10, 6, 14, 4, 20, 12, 8, 16
24	1, 17, 9, 5, 13, 21, 3, 19, 11, 7, 15, 23, 2, 18, 10, 6, 14, 22, 4, 20, 12, 8, 16, 24
28	1, 25, 17, 9, 5, 13, 21, 3, 27, 19, 11, 7, 15, 23, 2, 26, 18, 10, 6, 14, 22, 4, 28, 20, 12, 8, 16, 24
32	1, 25, 17, 9, 5, 13, 21, 29, 3, 27, 19, 11, 7, 15, 23, 31, 2, 26, 18, 10, 6, 14, 22, 30, 4, 28, 20, 12, 8, 16, 24, 32
36	1, 33, 25, 17, 9, 5, 13, 21, 29, 3, 35, 27, 19, 11, 7, 15, 23, 31, 2, 34, 26, 18, 10, 6, 14, 22, 30, 4, 36, 28, 20, 12, 8, 16, 24, 32
40	1, 33, 25, 17, 9, 5, 13, 21, 29, 37, 3, 35, 27, 19, 11, 7, 15, 23, 31, 39, 2, 34, 26, 18, 10, 6, 14, 22, 30, 38, 4, 36, 28, 20, 12, 8, 16, 24, 32, 40
44	1, 41, 33, 25, 17, 9, 5, 13, 21, 29, 37, 3, 43, 35, 27, 19, 11, 7, 15, 23, 31, 39, 2, 42, 34, 26, 18, 10, 6, 14, 22, 30, 38, 4, 44, 36, 28, 20, 12, 8, 16, 24, 32, 40
48	1, 41, 33, 25, 17, 9, 5, 13, 21, 29, 37, 45, 3, 43, 35, 27, 19, 11, 7, 15, 23, 31, 39, 47, 2, 42, 34, 26, 18, 10, 6, 14, 22, 30, 38, 46, 4, 44, 36, 28, 20, 12, 8, 16, 24, 32, 40, 48
52	1, 49, 41, 33, 25, 17, 9, 5, 13, 21, 29, 37, 45, 3, 51, 43, 35, 27, 19, 11, 7, 15, 23, 31, 39, 47, 2, 50, 42, 34, 26, 18, 10, 6, 14, 22, 30, 38, 46, 4, 52, 44, 36, 28, 20, 12, 8, 16, 24, 32, 40, 48
56	1, 49, 41, 33, 25, 17, 9, 5, 13, 21, 29, 37, 45, 53, 3, 51, 43, 35, 27, 19, 11, 7, 15, 23, 31, 39, 47, 55, 2, 50, 42, 34, 26, 18, 10, 6, 14, 22, 30, 38, 46, 54, 4, 52, 44, 36, 28, 20, 12, 8, 16, 24, 32, 40, 48, 56
60	1, 57, 49, 41, 33, 25, 17, 9, 5, 13, 21, 29, 37, 45, 53, 3, 59, 51, 43, 35, 27, 19, 11, 7, 15, 23, 31, 39, 47, 55, 2, 58, 50, 42, 34, 26, 18, 10, 6, 14, 22, 30, 38, 46, 54, 4, 60, 52, 44, 36, 28, 20, 12, 8, 16, 24, 32, 40, 48, 56
64	1, 57, 49, 41, 33, 25, 17, 9, 5, 13, 21, 29, 37, 45, 53, 61, 3, 59, 51, 43, 35, 27, 19, 11, 7, 15, 23, 31, 39, 47, 55, 63, 2, 58, 50, 42, 34, 26, 18, 10, 6, 14, 22, 30, 38, 46, 54, 62, 4, 60, 52, 44, 36, 28, 20, 12, 8, 16, 24, 32, 40, 48, 56, 64
68	1, 65, 57, 49, 41, 33, 25, 17, 9, 5, 13, 21, 29, 37, 45, 53, 61, 3, 67, 59, 51, 43, 35, 27, 19, 11, 7, 15, 23, 31, 39, 47, 55, 63, 2, 66, 58, 50, 42, 34, 26, 18, 10, 6, 14, 22, 30, 38, 46, 54, 62, 4, 68, 60, 52, 44, 36, 28, 20, 12, 8, 16, 24, 32, 40, 48, 56, 64
72	1, 65, 57, 49, 41, 33, 25, 17, 9, 5, 13, 21, 29, 37, 45, 53, 61, 69, 3, 67, 59, 51, 43, 35, 27, 19, 11, 7, 15, 23, 31, 39, 47, 55, 63, 71, 2, 66, 58, 50, 42, 34, 26, 18, 10, 6, 14, 22, 30, 38, 46, 54, 62, 70, 4, 68, 60, 52, 44, 36, 28, 20, 12, 8, 16, 24, 32, 40, 48, 56, 64, 72
76	1, 73, 65, 57, 49, 41, 33, 25, 17, 9, 5, 13, 21, 29, 37, 45, 53, 61, 69, 3, 75, 67, 59, 51, 43, 35, 27, 19, 11, 7, 15, 23, 31, 39, 47, 55, 63, 71, 2, 74, 66, 58, 50, 42, 34, 26, 18, 10, 6, 14, 22, 30, 38, 46, 54, 62, 70, 4, 76, 68, 60, 52, 44, 36, 28, 20, 12, 8, 16, 24, 32, 40, 48, 56, 64, 72
80	1, 73, 65, 57, 49, 44, 33, 25, 17, 9, 5, 13, 21, 29, 37, 45, 53, 61, 69, 77, 3, 75, 67, 59, 51, 43, 35, 27, 19, 11, 7, 15, 23, 31, 39, 47, 55, 63, 71, 79, 2, 74, 66, 58, 50, 42, 34, 26, 18, 10, 6, 14, 22, 30, 38, 46, 54, 62, 70, 78, 4, 76, 68, 60, 52, 44, 36, 28, 20, 12, 8, 16, 24, 32, 40, 48, 56, 64, 72, 80
84	1, 81, 73, 65, 57, 49, 44, 33, 25, 17, 9, 5, 13, 21, 29, 37, 45, 53, 61, 69, 77, 3, 83, 75, 67, 59, 51, 43, 35, 27, 19, 11, 7, 15, 23, 31, 39, 47, 55, 63, 71, 79, 2, 82, 74, 66, 58, 50, 42, 34, 26, 18, 10, 6, 14, 22, 30, 38, 46, 54, 62, 70, 78, 4, 84, 76, 68, 60, 52, 44, 36, 28, 20, 12, 8, 16, 24, 32, 40, 48, 56, 64, 72, 80
88	1, 81, 73, 65, 57, 49, 44, 33, 25, 17, 9, 5, 13, 21, 29, 37, 45, 53, 61, 69, 77, 85, 3, 83, 75, 67, 59, 51, 43, 35, 27, 19, 11, 7, 15, 23, 31, 39, 47, 55, 63, 71, 79, 87, 2, 82, 74, 66, 58, 50, 42, 34, 26, 18, 10, 6, 14, 22, 30, 38, 46, 54, 62, 70, 78, 86, 4, 84, 76, 68, 60, 52, 44, 36, 28, 20, 12, 8, 16, 24, 32, 40, 48, 56, 64, 72, 80, 88

## NOTE:

(1) The number assigned at each bolt location represents the sequential order for tightening the bolt.

yield strength of the bolt material (see also para. 8.2.2 regarding the effect of short bolts on the determination of the Target Torque value). This range is normally only exceeded in exceptional cases that have been assessed by a qualified engineer. However, any maximum Target Bolt Prestress must be selected to ensure that all three of the joint components — bolts, flange, and gasket — are stressed within acceptable limits. (See also para. O-1.2.)

Section 12 provides guidance on the determination of the assembly Target Torque value.

Appendix O outlines a method to determine the assembly bolt stress for a given flange joint (bolt, flange, gasket assembly). The method is based on a formula and flange stress limits that are supported by and consistent with elastic-plastic FEA work. A calculation is provided that uses an example-specific maximum allowable gasket stress; however, the user must provide this information. Tables for maximum bolt load limits are provided for ASME B16.5/B16.47 Series A flanges and the method to calculate the assembly bolt load for other standard and nonstandard flanges is outlined.

### 10.1 Tightening Method/Load-Control Technique

(a) Several tightening methods are available such as hand wrench, slug/hand wrench, impact wrench, torque tools, and tension tools. Also, several load-control techniques are available. Thus, several combinations of specific joint assembly methods/techniques are available for consideration.

(b) Four such combinations that are commonly used are listed as follows in ascending order of bolt-load control accuracy; however, the implied bolt-load control accuracy is dependent on assembly procedures, specific material properties, and operator training and competency:

(1) tightening with hand or impact wrenches. Hand wrenches are practical only for bolts approximately 25 mm (1 in.) in diameter and smaller.

(2) tightening with hand-operated or auxiliary-powered tools with torque measurement. Hand-operated torque wrenches are practical only for bolts with assembly torque less than approximately 700 N·m (500 ft-lb).

(3) tightening with tensioning tools that apply an axial load to the bolt with force measurement.

(4) any tightening method used with bolt elongation (stretch) or load-control measurement. Bolt materials and properties vary within bolt types and this must be accounted for when using these methods.

(c) The selection of the tightening method/load-control technique for the joint under consideration should be made based on past experience with similar joints and full consideration of the risks (safety, environmental, financial) associated with potential leaks for the service conditions under consideration. For example, it is widely recognized that the most accurate bolt preload

control method ( $\pm 10\%$  or less) is direct measurement of residual bolt elongation (stretch) after tightening (see para. 10.2), whereas large bolt load variations are possible when any tightening method alone, not followed by stretch/load verification, is used. Use of hydraulic bolt tensioners results in accurate application of initial axial load to the bolts; however, this initial load is decreased due to transfer-load losses when the load from the hydraulic bolt tensioner is transferred to the nut on the tensioner side of the joint. Therefore, if tensioners are employed to obtain the target residual preload, use the procedure recommended by personnel who are experienced and qualified in controlled bolting services. Most tensioning tools require additional bolt length.

(d) Regarding direct measurement of residual bolt elongation, it should be recognized that, if ultrasonic or micrometer elongation control is used, initial bolt length readings must be obtained and documented for each bolt for which bolt elongation is to be determined; additionally, compensation must be made for temperature changes in the bolt after the initial length measurement. For accuracy, the instrument should be calibrated to properly read the bolts being tightened. Information stored in the instrument or tabled values may be too generic to produce the desired level of accuracy. For bolts constructed with a centerline indicator (gage) rod as shown in Figs. 1 and 2, neither initial length measurements nor temperature compensation is required, thereby allowing direct determination of the true bolt elongation (and hence bolt stress) for both initial assembly and for troubleshooting purposes during operation.

(e) Proprietary force-sensing devices that can provide accurate and reliable real-time (increasing and decreasing) bolt tension readings/printouts are available from several manufacturers.

### 10.2 Bolt Elongation (Bolt Stretch) Determination

When bolt elongation (bolt stretch) measurement is selected as the load-control technique to be used, the required bolt elongation is computed according to the following equation (assumes the bolt is threaded full length):

$$\Delta L = \left( \frac{S_b \times L_{eff}}{E} \right) \left( \frac{A_r}{A_{ts}} \right)$$

where

$A_r$  = root area,  $\text{mm}^2$  ( $\text{in.}^2$ ). See Appendix H for bolt root areas.

$A_{ts}$  = tensile stress area,  $\text{mm}^2$  ( $\text{in.}^2$ ). See Appendix H for bolt tensile stress areas.

$E$  = modulus of elasticity, MPa (ksi)

$L_{eff}$  = effective stretching length, mm (in.). The conventional assumption is that the effective stretching length in a through-bolted joint system is the distance between mid-thickness of the nuts, where the nominal thickness of a

Fig. 1 Indicator-Type Bolting for Through-Bolted Joints

TABLE A		TABLE B					
Nominal Bolt Diameter, in.	Indicator Rod Diameter, in.	Hole Diameter, in.	Quantity Required	Nominal Bolt Diameter	L	Materials	Washers [Note (1)]
7/8-1 1/4	1/8	0.188 +0.003 -0.000				Bolts	
1 3/8-1 7/8	3/16	0.250 +0.004 -0.000				Nuts	
2 and over	1/4	0.313 +0.004 -0.000					

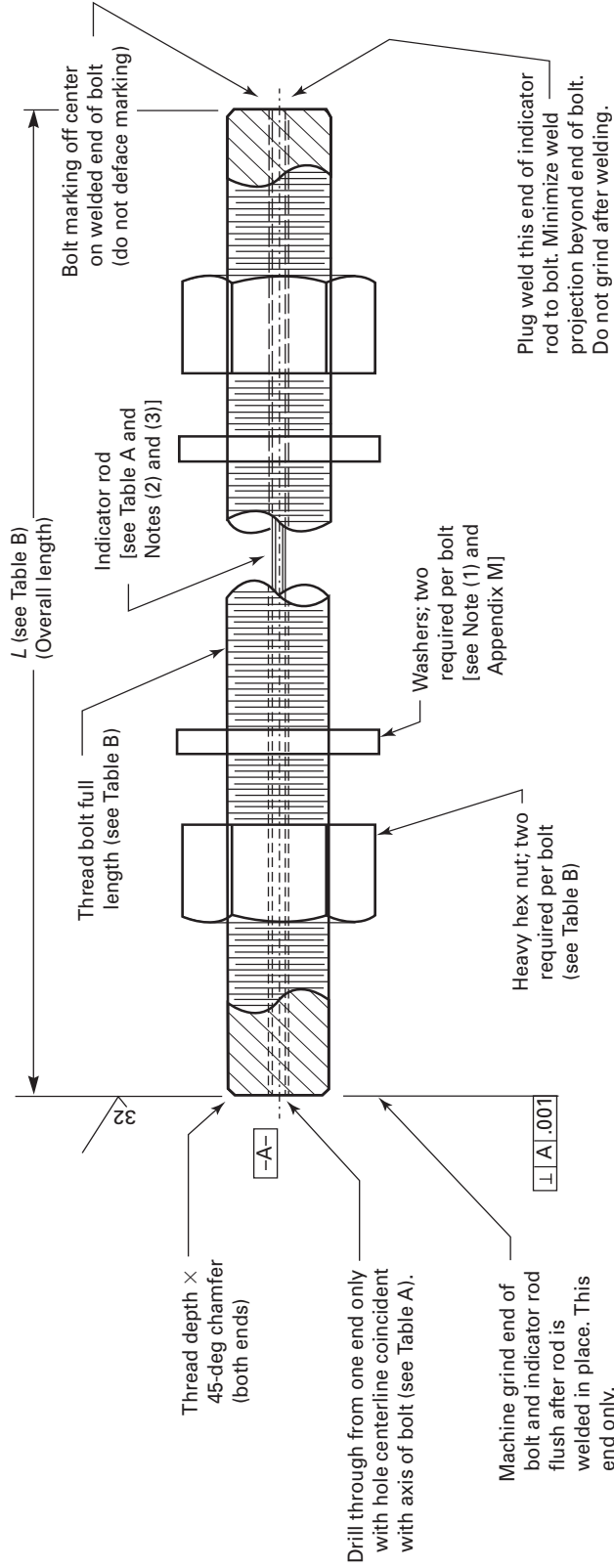

NOTES:

- (1) Washers are required only when torquing methods (versus use of hydraulic tensioners) are used for bolt tightening.
- (2) Indicator rod material for low-alloy steel bolting (e.g., SA-193 GR-B7) shall be nickel alloy UNS N10276 (C-276) bare welding rod per AWS A5.14. Indicator rod material for other bolting shall be same as bolt, or a material having essentially the same coefficient of expansion and a composition suitable for welding to the bolt.
- (3) Indicator rod diameter shall be reduced by centerless grinding if necessary to provide free-fall movement of rod before welding.

For Item Number \_\_\_\_\_, see Reference Drawing \_\_\_\_\_.

Indicator-Type Bolting for Through-Bolted Joints			
Drawn by	Checked by	Approved by	Drawing Number

Fig. 2 Indicator-Type Bolting for Studded Joints

TABLE A		TABLE B								
Nominal Bolt Diameter, in.	Indicator Rod Diameter, in.	Hole Diameter, in.	Quantity Required	Nominal Bolt Diameter	L	Bolts	Nuts	Washers [Note (1)]	Dimensions	
7/8-1 1/4	1/8	0.188 ±0.003 -0.000							C	D (dia)
1 3/8-1 7/8	3/16	0.250 ±0.004 -0.000								
2 and over	1/4	0.313 ±0.004 -0.000								

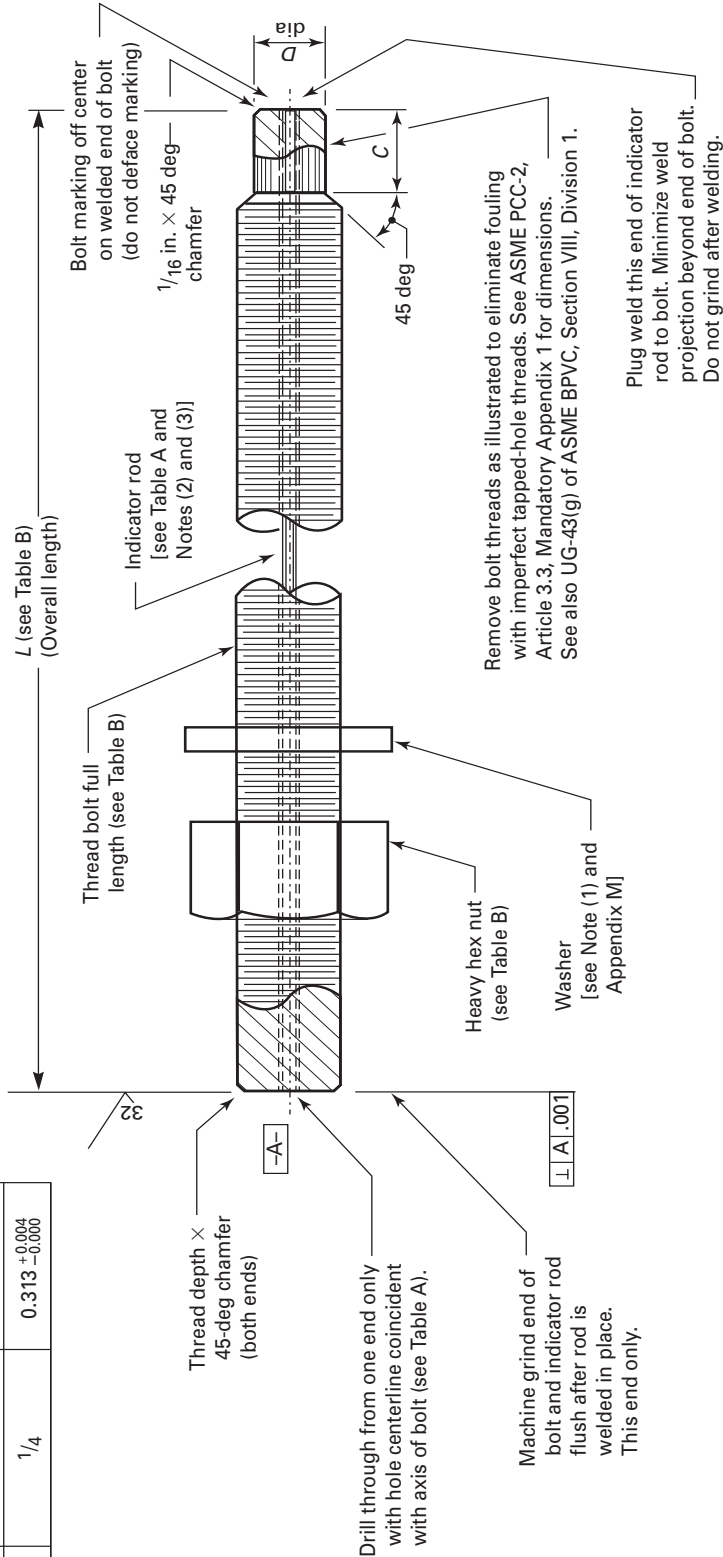

NOTES:

- (1) Washers are required only when torquing methods (versus use of hydraulic tensioners) are used for bolt tightening.
- (2) Indicator rod material for low-alloy steel bolting (e.g., SA-193 GR-B7) shall be nickel alloy UNS N10276 (C-276) bare welding rod per AWS A5.14. Indicator rod material for other bolting shall be same as bolt, or a material having essentially the same coefficient of expansion and a composition suitable for welding to the bolt.
- (3) Indicator rod diameter shall be reduced by centerless grinding if necessary to provide free-fall movement of rod before welding.

For Item Number \_\_\_\_\_, see Reference Drawing \_\_\_\_\_.

Indicator-Type Bolting for Studded Joints			
Drawn by	Checked by	Approved by	Drawing Number

heavy hex series nut is one nominal bolt diameter. By the same standard, the effective length of the portion of a bolt that is studded into a tapped hole is one-half of a nominal bolt diameter.

$S_b$  = Target Bolt Stress (root area), MPa (ksi). It is noted that bolt stresses computed in accordance with Mandatory Appendix 2 of Section VIII, Division 1 of the ASME Boiler and Pressure Vessel Code are based on root area. If Target Bolt Stress (tensile stress area) is used, drop the  $A_r/A_{ts}$  term from the  $\Delta L$  computation.

$\Delta L$  = bolt elongation (bolt stretch), mm (in.). Select a tolerance on this computed value and include it in the joint assembly procedure.

### 10.3 Tightening Method/Load-Control Technique Selection

Table 3 shows an example of an approach to selecting the tools, tightening method, and load-control technique suitable to the need.

NOTE: Table 3 is provided as an illustration; due consideration of specific conditions and factors applicable to the joint under consideration should be given when selecting the appropriate tightening method/load-control technique combination for a given application.

### 10.4 Start-Up Retorque

On joints that are problematic, or have been determined to have insufficient buffer against leakage in accordance with Appendix O, a start-up retorque may be performed to decrease the likelihood of leakage during operation.<sup>7</sup> Start-up retorque is performed when the temperature of the flange or bolts is between 150°C (300°F) and 230°C (450°F) or within 24 h of unit start-up if the joint temperature remains below 150°C (300°F). This temperature range and time window is selected to allow for the maximum amount of gasket relaxation prior to retightening while avoiding significant evaporation of lubricating oils from the antiseize product. Loss of lubricating oils greatly reduces the accuracy of the torque. The applied torque is sometimes adjusted to account for changes in antiseize nut factor at the average start-up retorque temperature. Start-up retorque is typically not recommended for PTFE-based gaskets. Where start-up retorque is not practical, live tightening at a later stage of operation using turn-of-nut may be used as an alternative.

The start-up retorque is performed in accordance with the following procedure:

<sup>7</sup> If joint-tightening activities are performed on pressurized equipment, there is a risk of gasket blowout due to the disruption of the joint. Gasket blowout or leakage may occur at a location around the periphery of the joint other than the one being tightened. This risk should be considered, particularly with respect to personnel in the vicinity of the joint.

(a) The ambient-temperature assembly Target Torque value should be adjusted to account for any change in nut factor with temperature.

(b) Once the unit is brought online and the metal temperature is between 150°C (300°F) and 230°C (450°F) (commence once the flange reaches the lower temperature) or within 24 h of unit start-up if the joint temperature remains below 150°C (300°F), then proceed in a circular pattern and tighten each bolt. The use of multitool tightening on opposing bolts is an acceptable practice, but a circular pattern should be used.

(c) Continue tightening in the circular pattern until the nuts no longer turn.

An engineering and risk analysis of the proposed start-up retorque operation shall be carried out to establish that the operation can be performed safely. Start-up retorque should not be considered the same as live tightening or hot bolting (see Appendix B). Live tightening or hot bolting are post-assembly activities usually undertaken due to leakage or maintenance requirements and are covered further in ASME PCC-2.

## 11 TIGHTENING SEQUENCE

### 11.1 Single-Tool Usage

Select from the following:

(a) The Table 4 Legacy pattern and numbering system.

(b) The Table 4.1 modified Legacy pattern and numbering system.

(c) The alternative pattern sequences shown in Alternatives #1, #2, and #3 of Appendix F; compliance with the stated limitations for their application is essential.

The torque increment round-tightening information for the Table 4 Legacy pattern is detailed in Table 2 (see Figs. 3 and 4 for an illustration of the Legacy cross-pattern tightening sequence for a 12-bolt flange and a 48-bolt flange, respectively, the latter illustrating the bolt-grouping concept). Counterpart illustrations of certain alternative pattern sequences are covered in Appendix F.

NOTE: The cross-pattern bolt-tightening sequence and multi-round tightening are necessary to counter the elastic interaction that occurs when tightening bolts. See Appendix I for additional information regarding elastic interaction (or bolt cross-talk).

### 11.2 Multiple-Tool Usage

Follow the procedures outlined in Alternatives #4 and #5 of Appendix F.

### 11.3 Measurement of Gaps

For the purpose of maintaining parallelism during the initial tightening passes of assembly, take measurements of the gap between flanges around the circumference. Measurements and adjustments are not needed past this

**Fig. 3 Example Legacy and Alternative to Legacy Numbering Sequences for 12-Bolt Joint**

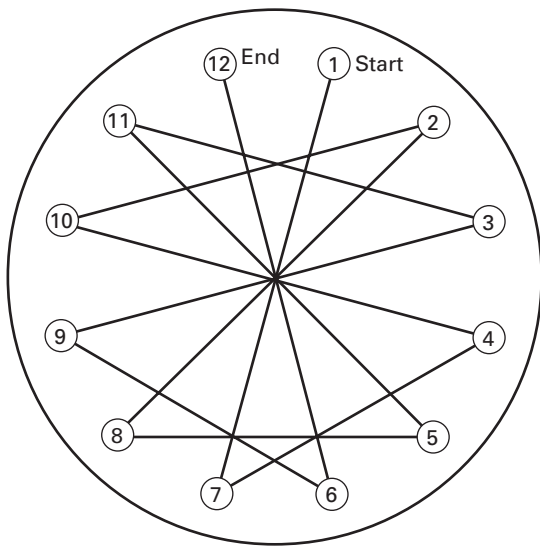

**(a) Legacy (see Table 4)**

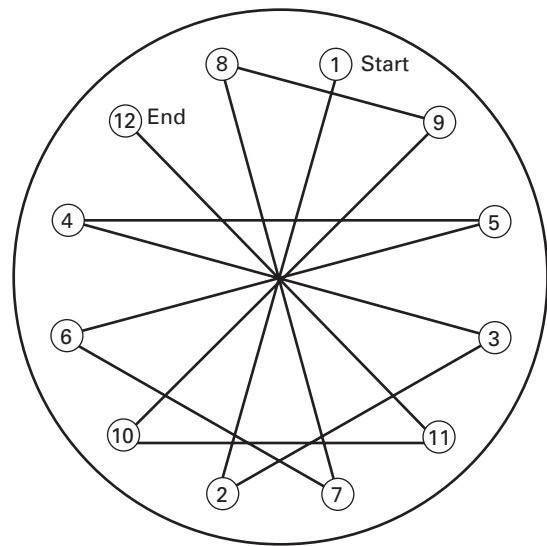

**(b) Alternative to Legacy (see Table 4.1)**

**Fig. 4 48-Bolt Flange Bolt-Grouping Example**

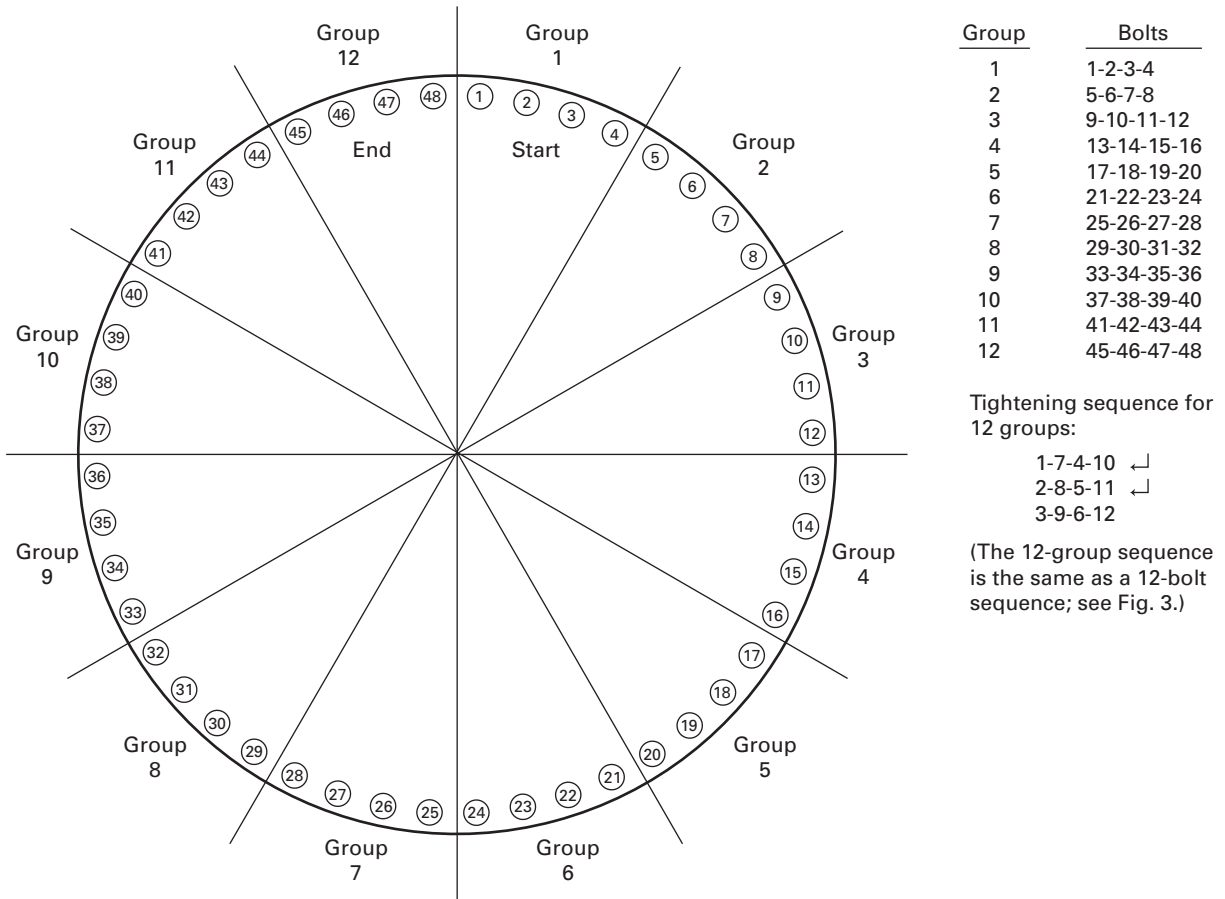

GENERAL NOTE: This figure is an illustration of how bolts may be grouped for tightening. Bolts may be grouped and tightened treating these groups as one bolt in the tightening sequence. A suggested number of bolts for a group is the number contained within a 30 deg arc. However, potential gasket damage or flange misalignment should be considered when bolts are grouped.

point if the flanges remain parallel. Measure the gap between flanges at eight or more equally spaced locations of good-quality flange surface around the circumference. Use a measuring device that allows for good comparison between points. Gap measurements are not intended as indicators of gasket stress. Loosen bolts in the vicinity of the low readings (smallest gap between flanges), until the gap is uniform to within 0.25 mm (0.010 in.). If necessary, bolts at the location of the highest readings (largest gap between flanges) can be tightened. However, if the difference in torque required to keep the gap uniform is greater than 50%, disassemble the joint and locate the source of the problem.

## 12 TARGET TORQUE DETERMINATION

Individually determine the Target Bolt Prestress for each joint considering each joint element that will be affected by the prestress, keeping in mind that the initial load developed by this prestress is imposed entirely on the full gasket area unless the gasket has a stop-ring or the flange face detail is arranged to provide the equivalent. Before selecting Target Torque, see section 10, Tightening of Bolts; and Appendix O, Assembly Bolt Stress Determination.

### 12.1 Target Prestress

The Reference Torques for a Target Prestress of 345 MPa (50 ksi) (root area) are given in Table 1M/ Table 1. Target Torques for different Target Prestress levels may be obtained by reducing (or increasing) the values in Table 1M/ Table 1 by the ratio

$$\text{or } \frac{\text{Target Prestress (MPa)}}{345 \text{ (MPa)}}$$

$$\frac{\text{Target Prestress (ksi)}}{50 \text{ (ksi)}}$$

See Appendix J for calculation of Target Torque for coefficients of friction other than those listed in Note (1) of Table 1M/ Table 1. See Appendix K for an alternative method of calculating Target Torque when nut factors are used.

## 13 JOINT PRESSURE AND TIGHTNESS TESTING

Bolted joint assemblies should be tested to ensure leak tightness. Subject to code/regulatory requirements, the user should establish

- (a) the type of leak test (e.g., visual, bubble-forming solution, sniffer)
- (b) test fluid (e.g., air, inert gas, water, service fluid)
- (c) test pressure (e.g., low pressure or up to a code-mandated visual inspection pressure)
- (d) acceptance criteria (often simply “no detectable leaks”)

The user is also cautioned to consider that the practice of using “temporary” gaskets for pressure or tightness testing of systems that include bolted flange joint assemblies has resulted in numerous incidents of injury and near injury to assembly personnel due to “blowout” failure of these alternative gasket materials/types. The use of substitute gaskets during testing instead of those designed as the final seal for the joint is not recommended.

Refer to ASME PCC-2, Article 5.1 for general good practices for pressure and tightness testing of pressure equipment.

## 14 RECORDS

Consideration should be given to the preparation of a joint assembly record for each assembled joint, particularly those that are deemed to be in critical service or deemed to be prone to leakage.

### 14.1 Documentation of Authorized Agent

As described in the Note at the end of section 2, the term “user” is understood to include the user or their authorized agent. Such authorization should be recorded in either the contract documents or the written assembly procedures.

### 14.2 Joint Assembly Records

Joint assembly records may include the following information:

- (a) joint location or identification
- (b) joint class and size
- (c) specifications and conditions of flanges, fasteners, washers (including nut- or washer-bearing surfaces), and gaskets
- (d) date of activity (assembly, disassembly, pressure test, etc.)
- (e) names of assemblers/workers
- (f) name of inspector or responsible person (see Appendix G)
- (g) disassembly method
- (h) adverse disassembly conditions, such as the presence of nut seizing or thread galling
- (i) leak history
- (j) bolts, nuts, and washers used
- (k) flatness measurements, when made (see Appendix D)
- (l) assembly procedure and tightening method used, including applicable Target Prestress values as per the indicated tightening method
- (m) unanticipated problems and their solutions
- (n) tool data such as type, model, pressure setting, and calibration identification
- (o) tool access or safety issues
- (p) recommendations for future assembly procedures and joint maintenance and repairs

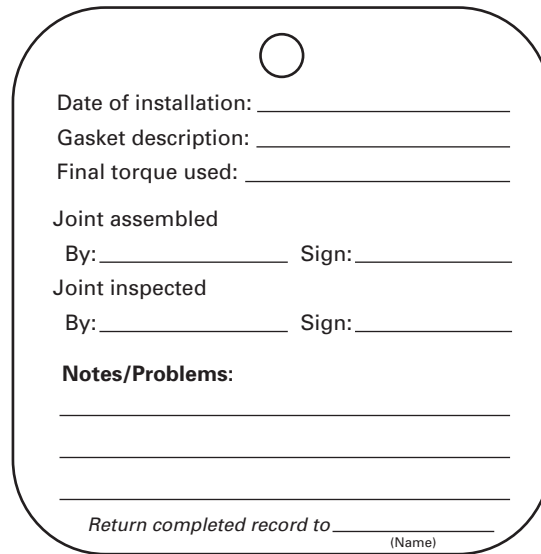

**Fig. 5 Example Short Assembly Record**

○

Date of installation: \_\_\_\_\_

Gasket description: \_\_\_\_\_

Final torque used: \_\_\_\_\_

Joint assembled

By: \_\_\_\_\_ Sign: \_\_\_\_\_

Joint inspected

By: \_\_\_\_\_ Sign: \_\_\_\_\_

**Notes/Problems:**

\_\_\_\_\_

\_\_\_\_\_

\_\_\_\_\_

*Return completed record to \_\_\_\_\_*  
(Name)

Examples of three different types of joint assembly records are shown in Figs. 5 through 7. An example of a joint leakage record is shown in Form P-3.4.

Often, the first step in maintaining joint assembly records is to uniquely identify each joint. The unique identifier should ideally be permanently fixed to the joint using a marking or tag system that enables an assembler to verify that they have the correct joint prior to working on it. Such a system enables storage of joint assembly records against the unique joint identifier and minimizes the potential hazard associated with disassembly of the wrong joint.

Joint assembly records have two purposes.

(a) They facilitate joint assembly quality control by recording the individual responsible for a particular portion of the joint assembly process.

(b) They provide a record of the joint assembly parameters that were used and the lessons learned.

The first purpose is achieved by increasing the responsibility of the individual involved in assembling the joint by maintaining a record of their actions and identity. The second purpose is achieved by documenting the actual parameters used and observations made during joint assembly. This information will be useful if the joint leaks during operation, or for guidance during future assembly of the joint. It is essential that any deviations, comments, observations, or changes to the assembly procedure are fed back into the joint assembly record system, such that the assembly procedure may be updated prior to the next joint maintenance activity.

Users should decide what level of detail to record based on their own needs and resources. Due to the large numbers of pressure-boundary bolted joints assembled during construction and maintenance activities, it may not be practical to maintain a record of all joint assembly

parameters (i.e., the example record shown in Fig. 7). Therefore, this sort of record is often completed and archived only until the next assembly for joints that are the most critical or most likely to leak. The shortened record (i.e., the example records shown in Figs. 5 and 6) typically does not include all the joint assembly parameters or observations and is typically discarded after the unit start-up. This means that the second purpose is not achieved, but the more important effect of improving joint assembly quality control is still attained.

There is typically also a register of joints that is maintained, in addition to the joint assembly records, which tracks the progress of each joint, whether there is an assembly record or not. The register may incorporate the use of the joint assembly records by requiring visual confirmation of a completed record prior to the joint register being updated to show that the joint may be returned to service.

An additional note of guidance is that the tendency to provide or request too much information on the joint assembly record should be avoided. It should not be considered a substitute for written assembly procedures or assembler qualification.

## 15 JOINT DISASSEMBLY

Before any joint is disassembled, it is essential that assurance be obtained from personnel in responsible charge of the management of the system that all pressure, including that due to a liquid head, has been removed from the system and that proper procedures have been followed to ensure that joints may be safely opened.

A sufficient number of loosened nuts should be left in place until all tension has been relieved, to guard

**Fig. 6 Example Medium-Length Assembly Record**

<p><b>FRONT</b></p> <div style="border: 1px solid black; border-radius: 25px; padding: 10px; margin: 10px auto; width: 90%;"> <div style="text-align: center; margin-bottom: 10px;">○</div> <p><b>Joint Identification:</b>            Plant name: _____            Equipment/Dwg. no.: _____            Joint description no.: _____</p> <p><b>Joint Description:</b>            Diameter: _____            Pressure rating: _____            Gasket type/size: _____            Bolt/nut specification: _____            Bolt size and length: _____            Washer description: _____</p> <p><b>Assembly Parameters:</b>            Assembly method: _____            Assembly bolt stress: _____            Lubricant used: _____            Assembly torque: _____            Pump pressure: _____</p> <p><b>Tool Identification:</b>            List tool calibration identifiers:            _____            _____            _____</p> </div>	<p><b>BACK</b></p> <div style="border: 1px solid black; border-radius: 25px; padding: 10px; margin: 10px auto; width: 90%;"> <div style="text-align: center; margin-bottom: 10px;">○</div> <p><b>Joint Assembly Sign-Off:</b></p> <ol style="list-style-type: none"> <li>(1) Disassembled flange inspected</li> <li>(2) Gasket inspected pre-installation</li> <li>(3) Bolt pre-install (free-running)                By: _____ Sign: _____</li> <li>(4) Joint aligned                By: _____ Sign: _____</li> <li>(5) Bolts lubricated                By: _____ Sign: _____</li> <li>(6) Joint snug tightened                By: _____ Sign: _____</li> <li>(7) Joint 100% assembled                By: _____ Sign: _____</li> <li>(8) Joint leak tested (pressure = _____)                By: _____ Sign: _____</li> <li>(9) Final QC sign-off                Sign: _____ Date: _____</li> </ol> <p><b>Notes/Problems:</b>            _____            _____            _____</p> <p style="text-align: right; font-size: small;">Return completed record to _____ (Name)</p> </div>
---	--

**Fig. 7 Example Long Assembly Record**

**Joint Identification:**  
 Plant name: \_\_\_\_\_ Equipment/Dwg. no.: \_\_\_\_\_  
 Joint description/number: \_\_\_\_\_

**Joint Description:**  
 Diameter: \_\_\_\_\_ Pressure rating: \_\_\_\_\_  
 Gasket type and materials: \_\_\_\_\_  
 Gasket size (O.D., I.D., and thickness): \_\_\_\_\_  
 Bolt/nut specification: \_\_\_\_\_ Bolt size: \_\_\_\_\_ Bolt length: \_\_\_\_\_  
 Washer description: \_\_\_\_\_

**Assembly Description:**  
 Disassembly procedure required? Yes / No      Keep failed gasket? Yes / No  
 Assembly method to be used: \_\_\_\_\_  
 Target assembly bolt stress: \_\_\_\_\_  
 Torque or tension setting required: \_\_\_\_\_  
 Assembly re-torque required? Yes / No      Re-torque torque value: \_\_\_\_\_  
 Lubricant to be used: \_\_\_\_\_  
 Other special instructions: \_\_\_\_\_

---

**Tool Identification:**  
 List tool and pump (if applicable) unique calibration identifiers:  
 \_\_\_\_\_  
 \_\_\_\_\_

<p><b>Joint Assembly Sign-Off:</b></p> <p>(1) Disassembled flange inspected                  (2) Gasket inspected pre-install                  (3) Bolt pre-install (free-running)                  By: _____ Sign: _____                  (4) Joint alignment                  By: _____ Sign: _____                  (5) Bolts lubricated                  By: _____ Sign: _____                  (6) Joint snug tightened                  By: _____ Sign: _____                  (7) Joint 100% assembled                  By: _____ Sign: _____                  (8) Joint leak tested                  By: _____ Sign: _____                  (9) Final QC sign-off                  Sign: _____ Date: _____</p>	<p><b>Joint Assembly Parameter Records:</b></p> <p>Nut/washer bearing surface condition: _____                  Flange finish and flatness: _____                  Max. radial defect: _____ Defect depth: _____                  Max. run-out: _____ Max. warp: _____                  Joint alignment:                  Max. axial gap: _____                  Max. alignment load: _____                  Joint in-process alignment:                  Max. gap difference @ snug: _____                  Max. gap difference @ tight: _____                  Final pump pressure used: _____                  Joint leak test:                  Test pressure _____ Leak: Yes / No                  Action taken if leaked: _____</p>
--	---

**Notes/Problems:**  
 \_\_\_\_\_  
 \_\_\_\_\_  
 \_\_\_\_\_  
 \_\_\_\_\_

*Return completed record to* \_\_\_\_\_  
 (Name)

against falling components, or pipe spring or other unanticipated movement. Due to the possibility of residual liquid in the pipe along with any unrelieved pressure, the first bolts loosened should be in a location that will direct any pressure release away from the assembler. Generally, for joints in the vertical plane, this will be at the top of the joint and then at the bottom to drain the liquid.

When significant numbers of bolts are loosened in rotational order, the elastic recovery of the clamped parts can result in excessive loads on the relatively few remaining bolts, making further disassembly difficult and sometimes causing galling<sup>8</sup> between the nut and bolt sufficient to result in torsional failure of the bolt as further loosening is attempted. The reported incidents of disassembly difficulties have typically involved

- (a) flanges larger than DN 600 (NPS 24)
- (b) flange thicknesses greater than 125 mm (5 in.)
- (c) bolt diameters M45 (1¾ in.) and larger

Accordingly, use of a joint disassembly procedure may be desirable for joints involving components meeting all the criteria of paras. 15.1.1, 15.1.2, and 15.1.3. Also, use of a joint disassembly procedure may be prudent for joints involving components for which high local strains could be detrimental (e.g., glass-lined equipment, lens ring joints).

### 15.1 Disassembly Load Control

**15.1.1** When a joint disassembly load-control procedure is deemed appropriate, start by loosening bolts on a cross-pattern basis to approximately half the initial preload on each bolt based on the operator's judgment. If the breakaway torque action results in completely relieving all preload, retighten to approximately half the original Target Torque.

**15.1.2** Check the gap around the circumference after this first-stage loosening round is complete, and loosen additional bolts selectively if necessary to accomplish a reasonably uniform gap.

**15.1.3** After reaffirming that all pressure on the joint has been released and that the joint has separated, proceed with bolt loosening and nut removal.

**15.1.3.1** An aid such as a hydraulic or manual flange spreader may be used if necessary to separate the joint.

## 16 REFERENCES

### 16.1 General

The following is a list of publications referenced in this Guideline.

<sup>8</sup> Experience has shown that, when SA-193 Gr B7 bolts are used, the galling incidents can be avoided by using higher strength SA-194 Gr 4 nuts rather than SA-194 Gr 2 or 2H nuts.

### 16.2 API Publications

ANSI/API Standard 660, Shell-and-tube Heat Exchangers, 8th ed., August 2007

API Recommended Practice 686, Recommended Practices for Machinery Installation and Installation Design, 2nd ed., December 2009

Publisher: American Petroleum Institute (API), 1220 L Street, NW, Washington, DC 20005 (www.api.org)

### 16.3 ASME Publications

ASME B1.1-2003, Unified Inch Screw Threads (UN and UNR Thread Form)

ASME B16.5-2013, Pipe Flanges and Flanged Fittings: NPS ½ Through NPS 24 Metric/Inch Standard

ASME B16.20-2007, Metallic Gaskets for Pipe Flanges: Ring-Joint, Spiral-Wound, and Jacketed

ASME B16.47-2011, Large Diameter Steel Flanges: NPS 26 Through NPS 60 Metric/Inch Standard

ASME B31.3-2012, Process Piping

ASME B46.1-2009, Surface Texture (Surface Roughness, Waviness, and Lay)

ASME PCC-2–2011, Repair of Pressure Equipment and Piping

Publisher: The American Society of Mechanical Engineers (ASME), Two Park Avenue, New York, NY 10016-5990; Order Department: 22 Law Drive, P.O. Box 2900, Fairfield, NJ 07007-2900 (www.asme.org)

### 16.4 ASME Boiler and Pressure Vessel Code, 2013 Edition

Section II, Part A — Ferrous Material Specifications:

SA-105/SA-105M, Specification for Carbon Steel Forgings for Piping Applications

SA-182/SA-182M, Specification for Forged or Rolled Alloy and Stainless Steel Pipe Flanges, Forged Flanges, and Valves and Parts for High-Temperature Service

SA-193/SA-193M, Specification for Alloy-Steel and Stainless Steel Bolting Materials for High-Temperature or High Pressure Service and Other Special Purpose Applications

SA-194/SA-194M, Specification for Carbon and Alloy Steel Nuts for Bolts for High-Pressure or High-Temperature Service, or Both

SA-240/SA-240M, Specification for Chromium and Chromium–Nickel Stainless Steel Plate, Sheet, and Strip for Pressure Vessels and for General Applications

SA-453/SA-453M, Specification for High-Temperature Bolting Materials With Expansion Coefficients Comparable to Austenitic Steels

SA-540/SA-540M, Specification for Alloy-Steel Bolting Materials for Special Applications

SA-693, Specification for Precipitation-Hardening Stainless and Heat-Resisting Steel Plate, Sheet, and Strip

Section II, Part B — Nonferrous Material Specifications:  
SB-637, Specification for Precipitation-Hardening Nickel Alloy Bars, Forgings, and Forging Stock for High-Temperature Service

NOTE: ASME SA and SB material specifications are used in ASME PCC-1. ASTM material specifications may also be used or taken to apply, as allowed by the applicable code of construction, for the joint being considered.

Section VIII, Division 1 — Rules for Construction of Power Boilers

Publisher: The American Society of Mechanical Engineers (ASME), Two Park Avenue, New York, NY 10016-5990; Order Department: 22 Law Drive, P.O. Box 2900, Fairfield, NJ 07007-2900 (www.asme.org)

### 16.5 ASTM Publications

ASTM A829/A829M-06, Standard Specification for Alloy Structural Steel Plates

ASTM F436-11, Standard Specification for Hardened Steel Washers

ASTM F606-11a, Standard Test Methods for Determining the Mechanical Properties of Externally and Internally Threaded Fasteners, Washers, Direct Tension Indicators, and Rivets

ASTM F606M-13, Standard Test Methods for Determining the Mechanical Properties of Externally and Internally Threaded Fasteners, Washers, and Rivets (Metric)

Publisher: American Society for Testing and Materials (ASTM International), 100 Barr Harbor Drive, P.O. Box C700, West Conshohocken, PA 19428-2959 (www.astm.org)

### 16.6 AWS Publication

AWS A5.14/A5.14M:2011, Specification for Nickel and Nickel-Alloy Bare Welding Electrodes and Rods — 10th edition

Publisher: American Welding Society (AWS), 8669 Doral Boulevard, Doral, FL 33166 (www.aws.org)

### 16.7 European Committee for Standardization Publication

EN 1591-1:2001+A1:2009/AC:2011, Flanges and their joints — Design rules for gasketed circular flange connections — Part 1: Calculation method

Publisher: European Committee for Standardization (CEN), Avenue Marnix 17, B-1000 Brussels, Belgium (www.cen.eu)

### 16.8 ISO Publications

ISO 7005-1:2011, Pipe flanges — Part 1: Steel flanges for industrial and general service piping systems, 2nd ed.

ISO 27509:2012/Cor 1:2013, Petroleum and natural gas industries — Compact flanged connections with IX seal ring

Publisher: International Organization for Standardization (ISO), 1, ch. de la Voie-Creuse, Case postale 56, CH-1211, Genève 20, Switzerland/Suisse (www.iso.org)

### 16.9 U.S. Department of Labor/Occupational Safety and Health Administration Publication

29 CFR 1910.119, Process Safety Management of Highly Hazardous Chemicals

Publisher: Occupational Safety and Health Administration (OSHA), U.S. Department of Labor, 200 Constitution Avenue, NW, Washington, DC 20210 (www.osha.gov)

### 16.10 Japanese Standards Association Publication

JSA JIS B 2251:2008 (R2012), Bolt Tightening Procedure for Pressure Boundary Flanged Joint Assembly

Publisher: Japanese Standards Association (JSA), 4-1-24 Akasaka Minato-ku, Tokyo 107-8440 Japan (www.jsa.or.jp)

### 16.11 MSS Publication

MSS SP-9-2008, Spot Facing for Bronze, Iron and Steel Flanges

Publisher: Manufacturers Standardization Society of the Valve and Fittings Industry, Inc. (MSS), 127 Park Street, NE, Vienna, VA 22180-4602 (www.mss-hq.org)

### 16.12 PIP Publication

PIP VESV1002, Vessel Fabrication Specification for Vessels ASME Code Section VIII, Divisions 1 and 2, March 2012

Publisher: Process Industry Practices (PIP), Construction Industry Institute, The University of Texas at Austin, 3925 West Braker Lane (R4500), Austin, TX 78759 (www.pip.org)

### 16.13 WRC Publications

WRC Bulletin 449, Guidelines for the Design and Installation of Pump Piping Systems

WRC Bulletin 538, Determination of Pressure Boundary Joint Assembly Bolt Load

Publisher: Welding Research Council (WRC), P.O. Box 201547, Shaker Heights, OH 44120 (www.forengineers.org/wrc)

### 16.14 VDI Publication

VDI 2230:2003, Systematic calculation of high duty bolted joints — Joints with one cylindrical bolt

Publisher: Verein Deutscher Ingenieure (VDI), P.O. Box 10 11 39, 40002 Düsseldorf, Germany (www.vdi.de)

### 16.15 Other Publications

Bickford, John H., 1995. "An Introduction to the Design and Behavior of Bolted Joints," New York, Marcel Dekker, Inc.

Bickford, John H., and Nassar, Sayed, eds., 1998. "Handbook of Bolts and Bolted Joints," New York, Marcel Dekker, Inc.

Koves, W. J., 2005. "Design for Leakage in Flange Joints Under External Loads," Paper no. PVP2005-71254,

2005 Proceedings of the ASME Pressure Vessels and Piping Conference: Volume 2 — Computer Technology, ASME, New York, pp. 53–58

Payne, J. R., and Schneider, R. W., 2008. "On the Operating Tightness of B16.5 Flanged Joints," Paper no. PVP2008-61561, Proceedings of the ASME 2008 Pressure Vessels and Piping Conference, ASME, New York

# APPENDIX A

## TRAINING AND QUALIFICATION OF BOLTED JOINT ASSEMBLY PERSONNEL

### A-1 INTRODUCTION

#### A-1.1 Scope

**A-1.1.1 Background.** This Appendix was developed in response to a need expressed by some in the bolting services industry. It provides guidelines for establishing uniform criteria for training and qualifying bolted joint assembly personnel. It also provides guidelines for quality control of the program. *The recommendations outlined in this Appendix are intended as a guideline, and they may be applied differently by different user organizations.* The judgment either to apply or to not apply these guidelines rests entirely with the user. A user organization may utilize its in-house, company-specific program that is managed, audited, and maintained by an in-house qualified employee. The organization may or may not utilize the services of an Appendix A–Qualified Bolting Specialist.

User organizations who choose to utilize provisions of this Appendix should specify the level of qualification required. Examples include the following:

(a) An organization may require only one Appendix A–Qualified Bolting Specialist who works with a number of bolting assemblers.

(b) An organization may require that a group of Appendix A–Qualified Bolting Specialists work in the organization.

(c) An organization may require each assembly team working in a plant to be, as a minimum, led by an individual who is an Appendix A–Qualified Senior Bolting Specialist.

See also para. A-1.1.4.

#### A-1.1.2 Qualified Bolting Specialists, Qualified Senior Bolting Specialists, and Qualified Bolting Specialist Instructors

(a) This Appendix includes requirements for the training, qualification, duties, and responsibilities of Qualified Bolting Specialists, Qualified Senior Bolting Specialists, and Qualified Bolting Specialist Instructors engaged in the assembly and disassembly, including inspection and quality assurance, of

- (1) pressure vessel pressure-boundary bolted joints
- (2) piping pressure-boundary bolted joints
- (3) storage tank pressure-boundary bolted joints

(b) Additional supplemental qualifications may be obtained on the basic training to extend the qualifications, duties, and responsibilities to include

- (1) powered equipment
- (2) heat exchanger pressure-boundary bolted joints
- (3) special pressure-boundary bolted joints

The process for obtaining the various levels of qualification are outlined, for information, in Fig. A-1.

**A-1.1.3 Qualification.** ASME PCC-1, para. 3.1 recommends that joint assemblers and supervisors be qualified by an organization in accordance with the requirements contained in this Appendix.

In the qualification process, the Qualifying Organization conducts training, demonstrations, and practical and written examinations to determine a person's general knowledge of bolted joint assembly and related technical areas. No determination is made of an individual's capabilities in applying that knowledge within a specific work environment or under actual working conditions.

It remains the sole responsibility of the employer of the individual to determine the individual's competency for the task assigned.

**A-1.1.4 Covered Assembly Activities.** This Appendix can be applied to any person who is involved in the assembly/disassembly or quality assurance activities concerned with pressure vessel, piping, and tank bolted joints. It applies to persons typically employed by, but not limited to, the following:

- (a) jurisdictional authorities
- (b) manufacturers, installers, and maintainers of equipment
- (c) equipment owners and their employees
- (d) contract bolted joint assembly personnel
- (e) labor organizations
- (f) educational institutes

**A-1.1.5 Exempt Assembly Activities.** This Appendix does not cover personnel engaged in the assembly of structural-type bolted joints or pressure-boundary body joints on rotating equipment. These types of bolted joints are not covered by the minimum training curriculum outlined in this Appendix.

**Fig. A-1 Appendix Procedure Flowchart**

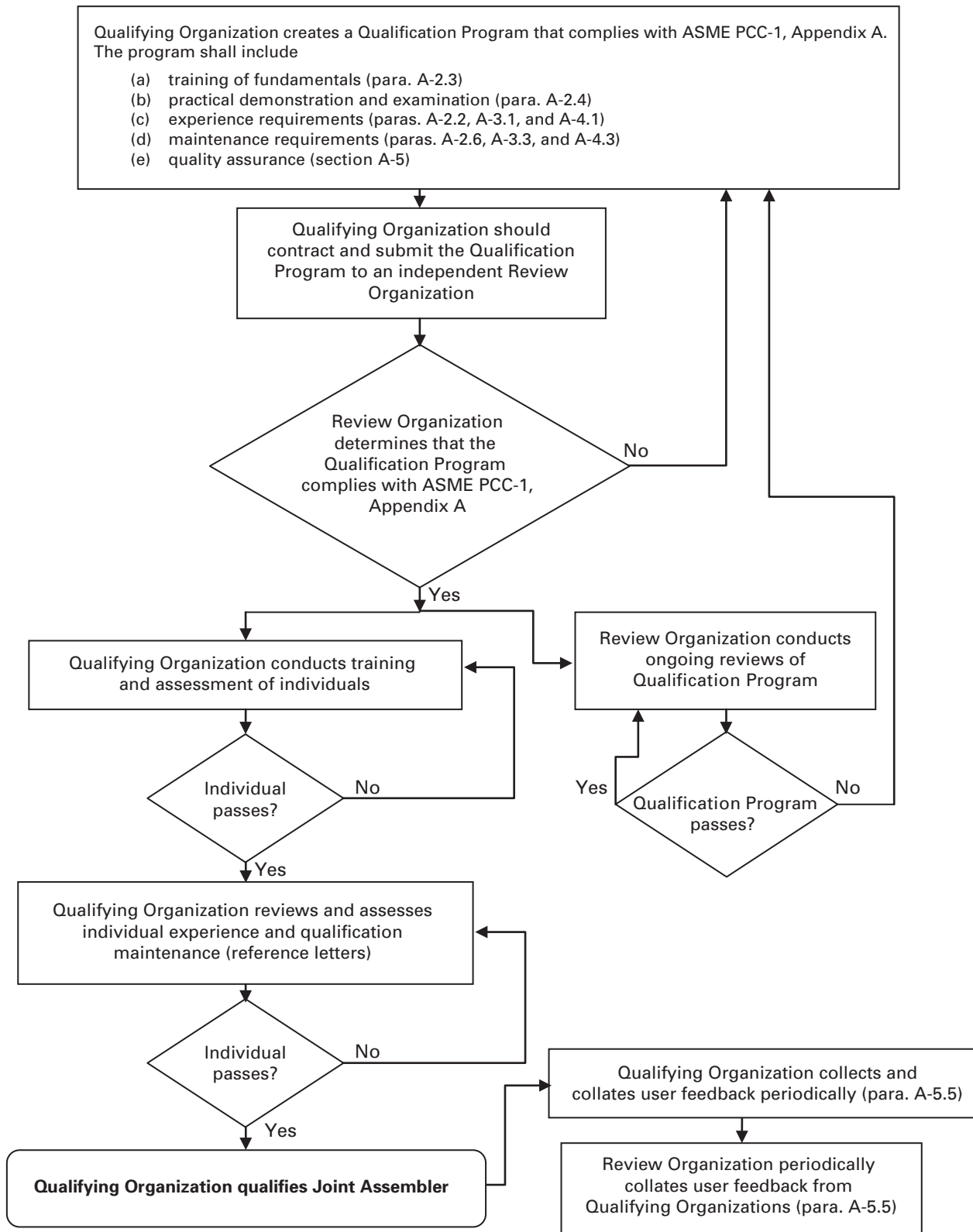



## A-1.2 Definitions

Terms used in this Appendix have the meanings specified in the following definitions. Other terms used have the meanings specified in section A-3 of this Appendix.

*ASME*: The American Society of Mechanical Engineers.

*backup wrench*: the tool used to secure the nut or bolt head opposite to the one being turned or torqued.

*bolting assembler*: a person meeting the experience qualifications of para. A-2.2 who is engaged in the assembly of bolted joints in accordance with the recommendations contained in ASME PCC-1 but has not yet received training and qualification from a Qualifying Organization.

*senior bolting assembler*: a person meeting the experience qualifications of para. A-3.1 who is engaged in the assembly of bolted joints in accordance with the recommendations contained in ASME PCC-1 but has not yet received training and qualification from a Qualifying Organization.

*bolting instructor*: a person meeting the experience qualifications of para. A-4.1 who is engaged in the assembly of bolted joints and the training of bolting assemblers in accordance with the recommendations contained in ASME PCC-1 but has not yet received training and qualification from a Qualifying Organization.

*bolting trainee*: a person undergoing training to become a Qualified Bolting Specialist.

*current edition*: the edition of the referenced code or standard that is specifically cited in ASME PCC-1 or was in effect at the time of publication of this version of ASME PCC-1.

*heat exchanger/tubesheet joints*: gasketed bolted joints that comprise the pressure-boundary closure between the tubesheet and the mating shell and tubeside girth flanges and that require special assembly considerations (see para. A-2.3.3). The gaskets for these joints are generally located entirely within the circle enclosed by the bolt holes, with no contact outside this circle; however, this is not intended to exclude other configurations, such as flat-faced flanges, from this Appendix.

*Industry Organization*: an organization that represents the interests of users of bolted joint assemblers.

*latest edition*: the latest edition in effect at the time of reference.

*Material Safety Data Sheet (MSDS)*: a data sheet for chemicals that defines important information such as the levels of toxicity, flammability, and first-aid actions required.

*personal protective equipment (PPE)*: the safety equipment (safety glasses, safety boots, earplugs, etc.) required to perform the assembly task.

*pipng joints*: similar to pressure vessel joints; however, considerations relating to alignment and external loadings on the joints can govern design and assembly

requirements. The gaskets for these joints are generally located entirely within the circle enclosed by the bolt holes, with no contact outside this circle; however, this is not intended to exclude other configurations, such as flat-faced flanges, from this Appendix.

*powered equipment*: hydraulic or pneumatic joint assembly equipment, such as a hydraulic torque wrench, pneumatic torque wrench, or hydraulic bolt-tensioning equipment.

*pressure vessel joints*: gasketed bolted joints that comprise the pressure-boundary closure between two flanges or between a flange and a blind. The gaskets for these joints are generally located entirely within the circle enclosed by the bolt holes, with no contact outside this circle; however, this is not intended to exclude other configurations, such as flat-faced flanges, from this Appendix.

*Qualification Manual*: the documentation of the Qualification Program in accordance with para. A-5.2.

*Qualification Program*: a Qualifying Organization's program, which is utilized to qualify bolting assemblers, senior bolting assemblers, and bolting instructors.

*Qualified Bolting Specialist*: a person qualified by a Qualifying Organization as meeting the requirements of section A-2 of this Appendix.

*Qualified Bolting Specialist Instructor*: a person qualified by a Qualifying Organization as meeting the requirements of section A-4 of this Appendix.

*Qualified Senior Bolting Specialist*: a person qualified by a Qualifying Organization as meeting the requirements of section A-3 of this Appendix.

*Qualifying Organization*: an organization that undertakes the training, demonstration, and practical and theoretical examinations outlined in this Appendix to qualify a bolted joint assembler.

*Review Organization*: an independent organization that conducts quality control reviews of the Qualification Program. Guidance for selection of Review Organizations is provided in para. A-5.3.2.

*ring-type joints (RTJ)*: flanges fitted with metal ring-type joint gaskets (as detailed in ASME B16.20).

*special joints*: any site- or process-specific flanged connection requiring different or additional instruction or considerations for assembly (such as clamped connectors, valve bonnets, and valve body joints).

*subject-matter expert (SME)*: an individual considered knowledgeable in the field of bolted joint assembly. Guidance for selection of SMEs is given in para. A-5.4.

## A-1.3 Reference Documents

Where the referenced standard or code does not include an effective date and a specific edition is not referenced in ASME PCC-1, the latest edition of the code or standard should be used.

**A-1.3.1 ANSI/API Standards**

ANSI/API Standard 660, Shell-and-tube Heat Exchangers, 8th ed., 2007

API Recommended Practice 686/PIP REIE-686, Recommended Practices for Machinery Installation and Installation Design, 2nd ed., 2009; Chapter 6, Sections 4.6 through 4.9 and Fig. B-4

Publisher: American Petroleum Institute (API), 1220 L Street, NW, Washington, DC 20005 (www.api.org)

**A-1.3.2 ASME Codes and Standards**

ASME B1.1-2003, Unified Inch Screw Threads (UN and UNR Thread Form)

ASME B1.7-2006, Screw Threads: Nomenclature, Definitions, and Letter Symbols

ASME B16.5-2013, Pipe Flanges and Flanged Fittings: NPS ½ Through NPS 24 Metric/Inch Standard

ASME B16.20-2012, Metallic Gaskets for Pipe Flanges: Ring-Joint, Spiral-Wound, and Jacketed

ASME B16.47-2011, Large Diameter Steel Flanges: NPS 26 Through NPS 60 Metric/Inch Standard

ASME B31.3-2012, Process Piping

ASME B46.1-2009, Surface Texture (Surface Roughness, Waviness, and Lay)

ASME Boiler and Pressure Vessel Code 2013, Section VIII, Division 1, Mandatory Appendix 2 and Nonmandatory Appendix S

ASME PCC-2–2011, Repair of Pressure Equipment and Piping, Articles 3.3, 3.5, and 5.1

Publisher: The American Society of Mechanical Engineers (ASME), Two Park Avenue, New York, NY 10016-5990; Order Department: 22 Law Drive, P.O. Box 2900, Fairfield, NJ 07007-2900 (www.asme.org)

**A-1.3.3 PIP Publication**

PIP VESV1002, Vessel Fabrication Specification for Vessels ASME Code Section VIII, Divisions 1 and 2, March 2012

NOTE: See also API Recommended Practice 686/PIP REIE-686 in para. A-1.3.1.

Publisher: Process Industry Practices (PIP), Construction Industry Institute, The University of Texas at Austin, 3925 West Braker Lane (R4500), Austin, TX 78759 (www.pip.org)

**A-1.3.4 U.S. Federal Regulations**

29 CFR 1910.119, Process Safety Management of Highly Hazardous Chemicals

Publisher: Occupational Safety and Health Administration (OSHA), U.S. Department of Labor, 200 Constitution Avenue, NW, Washington, DC 20210 (www.osha.gov)

**Table A-1 Guidance for Work-Site Experience**

Work-Site Experience	Equivalent Time Assessed
Frequent (joint assembly on a daily basis)	All time worked
Infrequent but with intense periods (joint assembly at least 1 week per month and at least a total of one-third the time worked in a year)	Half time worked
Sporadic (joint assembly at a frequency less than that for the "Infrequent" category, above)	Quarter time worked

**A-1.3.5 WRC Bulletin**

Caruci, V. A, and Payne, J. R. February 2000. WRC Bulletin 449, Guidelines for the Design and Installation of Pump Piping Systems

Publisher: Welding Research Council (WRC), P.O. Box 201547, Shaker Heights, OH 44120 (www.forengineers.org/wrc)

**A-1.3.6 Handbook**

Bickford, John H., 1995. "An Introduction to the Design and Behavior of Bolted Joints," New York, Marcel Dekker, Inc.

**A-2 REQUIREMENTS FOR QUALIFIED BOLTING SPECIALISTS****A-2.1 Qualifications**

A Qualified Bolting Specialist shall have received the training and shall possess practical experience to comply with the requirements outlined in this section. A Qualified Bolting Specialist shall verify that he or she meets the qualifications in paras. A-2.2 through A-2.6.

**A-2.2 Experience**

The bolting assembler shall have worked in the field with the assembly of bolted joints for at least 6 months full-time, or the equivalent part-time period as defined in Table A-1. The experience may be obtained prior to the required training and practical examinations as outlined in para. A-2.3 and para. A-2.4, respectively. The experience shall be sufficiently broad to ensure the individual has had exposure to more than half of the aspects covered in the training outlined in para. A-2.3. The experience should be documented by references from Senior Bolting Assemblers, Qualified Senior Bolting Specialists, or Qualified Bolting Specialist Instructors indicating that the field experience obtained meets the requirements of this Appendix. An example reference sheet is supplied in Form A-1. At least one reference should be from a supervisor at the individual's current or previous place of work. An individual may obtain the field experience



**Form A-1 (Back)**

---

---

7. What is your business relationship to the applicant? \_\_\_\_\_

8. How many years have you known the applicant? \_\_\_\_\_

9. Keeping in mind the intent to ensure that applicants for Bolting Specialist qualification have broad, prior work-site experience in bolted joint assembly that meets the intent of ASME PCC-1 Appendix A, para. A-2.2:

(a) Do you confirm that the applicant has worked in the field with the assembly of bolted joints for (please check one)

at least 6 months full-time, with frequent joint assembly on a daily basis?

No  Yes

at least 1 year with infrequent joint assembly, with intense periods occurring at least 1 week per month and at least a total of one-third of the time worked in that year?

No  Yes

at least 2 years with multiple, sporadic periods of joint assembly?

No  Yes

(b) In your estimation, has the applicant's bolted joint assembly work experience been sufficiently broad for him/her to develop a wide range of skills and knowledge necessary to form the foundation for further training and ultimate qualification as a Qualified Bolting Specialist?

No  Yes

10. Do you recommend the applicant for qualification as a Qualified Bolting Specialist?  No  Yes

11. Signature of reference: \_\_\_\_\_ Date: \_\_\_\_\_

subsequent to completion of the training, in which case they are not considered qualified until such time as they have sufficient experience to obtain their qualification.

In the case of an individual with either powered equipment, heat exchanger, or special joint supplemental qualifications, the experience shall include at least one-quarter of the time spent working on those items of equipment. Where the frequency of working on such equipment is less than this, the time period prior to achieving the supplemental qualification shall be extended until an equivalent period has passed.

### A-2.3 Training of Fundamentals

The Qualified Bolting Specialist shall have adequate training on the fundamentals of the assembly, operation, and quality assurance of bolted joints. Practical and theoretical examinations shall be given at the end of such training to ensure, to the satisfaction of a Qualified Bolting Specialist Instructor, that the candidate has attained awareness in the topics outlined in (a) through (t) below. The curriculum of this training shall ensure candidates are aware of the importance of the following issues when working with bolted joints. While some areas, such as health and safety, are outside the scope of ASME PCC-1, for completeness in describing a typical training course, they have been included below for purposes of awareness only. As a minimum, the following topics shall be addressed:

(a) *General Health and Safety Precautions.* Discuss common health issues and safety precautions per the requirements of applicable government health and safety regulatory bodies and plant-specific regulations. Ensure awareness in areas such as hazardous chemicals/gases, personal protective equipment (PPE), hazard communication, procedures for opening process equipment or piping, hearing protection, confined space entry, scaffold safety, personal fall protection, stairways and ladders, rigging, respiratory protection, asbestos considerations, walking and working surfaces, and job safety analysis, including

- (1) common procedures for work permits and ensuring system isolation
- (2) finger pinch points with assembly and alignment equipment
- (3) injury from tightening tools
- (4) working around heavy equipment (cranes and bundle pullers)
- (5) awareness of asbestos gaskets and fiber insulation or refractory dust

(b) general personal joint assembly equipment requirements

- (1) PPE — use of appropriate PPE is required at all times
- (2) flashlight, for checking gasket alignment/condition in joint

(3) tape measure, for checking component dimensions

(4) wire brush (material specific; e.g., stainless steel for stainless flanges and bolts)

(5) cleaner (material and process-medium compatible) and light dusting of gasket adhesive for vertical flanges; see section 6, subpara. (c)

(6) basic joint alignment equipment (pry-bar, drift pins; see Appendix E)

(7) site or corporate guidelines

(c) the principles of bolt elongation, bolt load, and gasket stress

(1) relationship between bolt stress and bolt elongation (see para. 10.2)

(2) relationship between bolt stress and gasket stress during assembly and operation (pressure and temperature effects)

(3) influence of bolt length on bolt-load loss due to gasket creep relaxation and surface embedment loss

(4) relationship between applied torque and achieved bolt stress/load

(5) bolting terminology, including common terms found in the field and their relationship to each other (e.g., kips, psig, psi, lb, ft-lb, N·m, ksi, tpi)

(d) functionality of gasket and seal

(1) purpose of a gasket

(2) effect of gasket stress on leak rate

(3) effect of bolt-load loss (creep/relaxation and operating conditions) on joint leakage and overall joint reliability

(e) gasket types and their limitations

(1) summary of common gasket types and materials

(2) sensitivity of different gasket types to assembly procedures

(3) maximum allowable gasket stress

(4) minimum required gasket stress

(5) awareness of the need for chemical compatibility

(6) awareness of temperature limits

(f) bolt types and their limitations

(1) brief detail of common bolting specifications, including yield strength

(2) nut-bolt combinations, nut strength versus bolt strength

(3) generic material temperature limits

(4) materials for stress-corrosion-cracking environments

(5) corrosion resistance

(6) coatings for assembly and disassembly

(g) identification of correct joint components

(1) bolt and nut identification marks

(2) installation of bolts and studs such that marked ends are all on same side of joint, with nut identification marks facing out, to facilitate inspection

- (3) flange identification marks
- (4) gasket identification marks and spiral-wound gasket color codes and types
- (5) use of piping-arrangement drawing or system diagram to identify and verify correct materials for gasket and fasteners
- (h) manual torque joint tightening
  - (1) working parts of a torque wrench
  - (2) setting required torque values on common types of wrenches
  - (3) bolting procedures (number of cross-pattern passes) required to achieve desired bolt torque (see section 9)
  - (4) accuracy of bolt torque tightening versus that of manual tightening
  - (5) variables affecting torque
- (i) the importance of using the specified lubricant (see section 7)
  - (1) purpose of lubricant
  - (2) effect of type of lubricant
  - (3) where to use lubricant (under nut and on bolt threads)
  - (4) limitations of lubricants, including oxygen ignition, oxidation, temperature, shelf life, catalyst poisoning, stress corrosion cracking, etc. (compatibility with process fluid and materials of construction)
  - (5) amount of lubricant to be used
  - (6) contamination of lubricants during assembly
  - (7) interpreting the label and MSDS information
- (j) techniques used for load control
  - (1) techniques used for load control by torque measurement
  - (2) techniques used for load control by hydraulic tension
  - (3) techniques used for load control by length or strain measurement (see paras. 10.1 and 10.2, and Figs. 1 and 2)
  - (4) accuracy of each method and relationship to service or joint criticality (see Table 3)
- (k) calibration and maintenance of bolt-tightening equipment
  - (1) requirements for maintenance of common field equipment
  - (2) inspection of common field equipment (especially torque wrenches)
  - (3) familiarization with methods for calibrating common field equipment
  - (4) importance and frequency of calibration
- (l) inspection and reporting defects or faults
  - (1) flange-face gasket contact surface inspection (see section 4 and Appendix D)
  - (2) acceptable levels of surface imperfections corresponding to different gasket types
  - (3) bolt inspection (thread form, corrosion, and free-running nut for triggering replacement; see section 4 and Appendix N)
  - (4) inspection of flange and nut contact surfaces (for galling, paint, or corrosion; see section 4)
  - (5) joint gap measurement (see section 11)
  - (6) joint tolerances and alignment (see Appendix E)
  - (7) joint-tightness leak check (see section 13)
- (m) procedure for preparing a joint for closure
  - (1) general work flow for inspecting and preparing a joint for closure
  - (2) methods for holding gasket in place (including the detrimental effects of excessive adhesive or use of nonapproved methods such as heavy grease or tape; see section 6)
  - (3) system cleanliness requirements
- (n) gasket handling, preparation, and installation
  - (1) use of a single, new (not used or damaged) gasket for final installation (see section 6)
  - (2) final inspection of gasket seal surface and gasket (dimensions, type, and damage)
  - (3) ensuring gasket can be inserted into joint without damage
  - (4) ensuring gasket is correctly located (use of flange bolts or light dusting of approved adhesive sprays)
- (o) sources of information on joint assembly
  - (1) ASME PCC-1
  - (2) corporate and site standards and specifications for gaskets and piping
  - (3) corporate and site standards for joint assembly
  - (4) corporate and site standards and specifications for bolt loads and assembly techniques
- (p) safe joint disassembly and assembly
  - (1) ensuring pressure isolation, valve-tagging systems, and safe work practices (see section 15)
  - (2) verification of pressure isolation, gas detection, and safe entry into system
  - (3) temporary support and/or rigging considerations for joint components
  - (4) working on internal joints and high-level or below-grade joints (scaffold and confined-space entry)
- (q) joint assembly procedures
  - (1) identification of correct assembly target bolt load
  - (2) reason for needing pattern passes in procedure
  - (3) reason for needing multiple passes in procedure (see Appendix I)
  - (4) measurement of joint gaps during assembly (see para. 11.1)
  - (5) hydraulic or pneumatic testing of joint after assembly (see section 13)
  - (6) measurement of joint gaps after assembly (see para. 11.1)
  - (7) use of proprietary backup wrenches and alignment tools, which may improve safety and speed of assembly

(r) ensuring correct use of additional joint components

(1) use of through-hardened washers (see Appendix M).

(2) use of conical disk (Belleville) spring washers.

(3) use of spacers or bolt collars for the purpose of additional effective length and elongation.

(4) use of prevailing torque nuts, instrumented studs, reaction washers, tensioning nuts, direct-tension-indicating washers, and other special-purpose accessories.

(5) use of proprietary nuts, washers, etc. There are innovative proprietary nuts, washers, and other mechanical and hydraulic devices that assist the assembly process and may have the capability to improve bolt-load accuracy and reduce scatter. Awareness of those devices should be included. Detailed training on the application of these devices is available from the supplier and/or manufacturer.

(6) use and misuse of locking devices and locking compounds.

(s) importance of joint quality-assurance procedures, certification, and records

(1) joint assembly procedures and typical forms

(2) joint assembly records (see section 14)

(3) certification systems for tracking equipment calibration

(4) the importance of a Joint Traveller sheet or assembly tag

(t) joint disassembly

(1) reasons for requiring a disassembly procedure (see section 15)

(2) disassembly procedures and critical issues

(3) use of nut splitters

**A-2.3.1 Piping-Specific Training Required for All Bolting Specialists.** This training forms part of the basic training to be given to all Qualified Bolting Specialists. As a minimum, the following shall be addressed:

(a) assembly technique and gasket recognition in relation to flange-face type

(1) flat face versus raised face versus RTJ and their appropriate gaskets

(2) understanding of ASME B16.5 and ASME B16.47 nominal pipe size and pressure class

(3) common flange types, including slip-on, weld-neck, socket weld, and lap joint/stub end

(4) installation and operational characteristics (rotation, stiffness, flange sealing area, etc.) of common flange types

(5) the importance of multipoint tightening on RTJ and lens ring joints

(6) the potential consequences of mating flat-faced flanges to raised-face flanges

(7) failure potential of brittle cast flanges on valves, pumps, and similar equipment

(b) tightening piping joints connecting to rotating equipment

(1) the need to ensure equipment alignment (shaft alignment) is not affected by external loads caused by assembly of piping connected to the rotating equipment

(2) equipment-allowable nozzle loads and moments

(3) purpose of piping expansion joints

(c) tightening piping joints on pressure relief devices

(1) potential for inspection work-hold point to ensure that there is no blockage in the relief path

(2) correct installation, gaskets, handling, and orientation of rupture discs and discharge lines

(3) confirmation of piping status by certified inspector (if required)

(d) tightening piping joints on and around piping expansion joints and spring hangers with cold-set

(1) methods of safely restraining bellows and cold-set spring hangers

(2) ensuring restraints are removed prior to operation

(3) how to recognize and report if too much force is required to bring the flanges together (see Appendix E)

(e) importance of alignment and gap uniformity

(1) Appendix E flange alignment tolerances

(2) tighter limits required for shorter or stiff spans

(3) importance of the bolts passing freely through the bolt holes so that the nuts rest parallel to the flange

(f) selecting the target bolt-assembly load

(1) parameters that determine appropriate bolt load (flange size, gasket type, flange class, flange type, flange material, bolt material, piping service)

(2) determination of correct load from gasket specifications and bolt size or flange class charts for torque and hydraulic tensioning (see section 12)

(3) discussion of the advantages and disadvantages of the tightening methods

(g) selecting appropriate bolt-tightening tooling

(1) acceptable methods in relation to bolt size

(2) naturally occurring clearance problems related to general styles of tooling such as hand torque wrenches, torque multipliers, and impact wrenches

(3) where to look for guidance (user specifications, company guidelines, tool manufacturer Web sites)

**A-2.3.2 Additional Training Required to Obtain a Powered Equipment Supplemental Qualification.** The curriculum shall ensure candidates have a thorough understanding of the following aspects of joint disassembly, assembly, and tightening using hydraulic or pneumatic-driven equipment. As a minimum, the following shall be addressed:

(a) general health and safety precautions

(1) safety and securing of high-pressure fluids, fittings, and hoses during operation

(2) placement and removal of backup wrench under high loads

(3) pinch points relative to hydraulic or pneumatic torque equipment and backup wrenches

(4) dangers associated with socket failure under load from using the incorrect or a low-quality socket

(b) hydraulic and pneumatic torque joint tightening

(1) working parts of hydraulic and pneumatic torque equipment

(2) working parts of a hydraulic pump and hydraulic/pneumatic regulator

(3) troubleshooting hydraulic wrench, hose, hose connections, and pump failures

(4) method of setting target torque

(5) method of using a hydraulic torque wrench

(6) single-point tightening versus simultaneous multiple-point tightening, and influence on the assembly procedure

(c) joint tightening using tensioning equipment

(1) working parts of a hydraulic bolt tensioner

(2) working parts of a hydraulic pump and hydraulic regulator

(3) method of setting correct bolt load (formulas for calculating the target bolt load) for the number of tools in relation to the number of bolts in the joint

(4) method of using a hydraulic bolt tensioner

(5) troubleshooting of tensioner, hose, hose connections, and pump failures

(6) use of a single tensioner versus simultaneous use of multiple tensioners and the influence of each on the assembly procedure (see Appendix L)

(7) effect of elastic recovery (indicated tensioner load in relation to final bolt load, need for overtension, and the effect of bolt grip-length to bolt-diameter ratio; see para. 8.2.2)

(d) calibration and maintenance of hydraulic bolt-tightening equipment

(1) requirements for maintenance of common hydraulic field equipment

(2) inspection of hydraulic hoses and cylinders

(3) familiarization with methods for calibrating common hydraulic field equipment

(4) importance and frequency of calibration

(e) selecting appropriate bolt-tightening tooling

(1) acceptable methods in relation to bolt size

(2) naturally occurring clearance problems related to general styles of tooling such as hydraulic inline ratchets, hydraulic square-drive ratchets, fixed-size tensioners, variable-size tensioners, hydraulic nuts, and mechanical jack nuts

(3) bolt-load limitation of hydraulic tensioners as related to pressure, ram size, bolt size, and bolt length

(4) use of comparative angle of nut rotation method when standard hydraulic tooling will not work (insufficient space for hydraulic equipment for one or two bolts)

**A-2.3.3 Additional Training Required to Obtain a Heat Exchanger Supplemental Qualification.** The curriculum shall ensure candidates have a thorough understanding of the following aspects of joint disassembly, assembly, and tightening for exchanger joints. As a minimum, the following shall be addressed:

(a) types of exchangers [Tubular Exchanger Manufacturers Association (TEMA) designations] and their joints

(1) joint configurations, terminology, and locations

(2) gasket configurations for the different types of joints

(3) confined gaskets versus unconfined gaskets

(4) measurement of final joint gaps as a measure of success

(b) bundle pushing and considerations for assembly

(1) bundle and channel orientation to align piping and pass-partition groove(s)

(2) risks during pushing (damage to the flange-face or shell gasket)

(c) tubesheet joint considerations, shellside gasket damage, and recompression of shellside gaskets on tube-sheet joints

(1) second gasket compression (more assembly passes may be required)

(2) risks if the shellside gasket seal is broken when the channel is removed (if bundle is not being pulled)

(3) inspection of pass-partition surfaces (pass-partition flush with flange facing)

(4) consideration of tightening shoulder-type bolts from both sides

(5) gasket pass-partition alignment

(d) Breechlock exchangers (optional)

(1) general sealing configuration of Breechlock exchangers

(2) special procedures for assembly of Breechlock (manufacturer's instructions)

**A-2.3.4 Additional Training Required to Obtain a Special Joint Supplemental Qualification.** The curriculum shall ensure candidates have a thorough understanding of all significant aspects of joint disassembly, assembly, and tightening for special joints. A comprehensive listing of the requirements is outside of the scope of these guidelines. However, the general approach used in the previous sections for piping and exchangers should be followed in formulating a training curriculum for special joints. The following general sections should, as a minimum, be covered:

(a) seal surface preparation

(b) the importance of alignment and gap uniformity

(c) gasket handling, preparation, and installation

(d) specific assembly steps, tooling, or procedures pertinent to the joint in consideration

(e) safety considerations, including lockout, depressurization, electrical isolation, and special work permits



## A-2.4 Practical Examination

The Qualified Bolting Specialist shall demonstrate his or her understanding in the assembly of bolted joints by taking part in at least one of the following range of bolted joint practical demonstrations and witnessing the other demonstrations. The demonstrations are designed to highlight significant aspects of the training curriculum and are to be performed in the presence, and to the satisfaction, of a Qualified Bolting Specialist Instructor. In addition, a practical examination of each candidate, requiring the assembly of at least two joints, shall be required. The criteria for pass/fail shall include measurement of the obtained gasket deformation and bolt-load variation and shall be assessed by a Qualified Bolting Specialist Instructor. The examination shall include all aspects of joint quality assurance that have been taught in the course.

In addition, for heat exchanger or special joint supplemental qualification, the practical examination shall include the assembly of a typical joint that falls within the supplemental qualification being sought. For powered-equipment supplemental qualification, a joint is to be assembled using both hydraulic tensioning and hydraulic torque equipment.

The following demonstrations are suggested to highlight several critical points of joint assembly. Alternative demonstrations or modifications to the outlined details may be substituted for any of the demonstrations, provided the desired learning points are still achieved, as judged by the Qualified Bolting Specialist Instructor.

### A-2.4.1 Importance of Gasket Placement

(a) Perform the following on a flange test rig having four or more bolts:

(1) Assemble a four-bolt, small-diameter flange with a spiral-wound gasket without inner and outer rings, using a tightening pattern, and ensure that about half of the gasket width is not on the raised-face portion on one side.

(2) Assemble a class 300, four-bolt, small-diameter flange with a class 150 spiral-wound gasket with outer rings, with the gasket in a vertical position, using a tightening pattern, and ensure that the outer ring of the gasket is located against the bolts.

(3) Assemble a four-bolt, small-diameter flange with a spiral-wound gasket without inner and outer rings, using a tightening pattern, and ensure the gasket is centrally located on the raised face.

(b) Inspect each gasket after disassembly to demonstrate uneven compression when not properly located.

### A-2.4.2 Importance of Joint Alignment Prior to Assembly

(a) Perform the following on a flange test rig having four or more bolts and equipped with a spring system that requires approximately 50% of the assembly bolt

load on the two upper bolts to bring the flanges into proper alignment:

(1) Assemble a joint with an expanded PTFE gasket, without aligning the flanges first (use flange bolts to align the joint).

(2) Assemble a joint with an expanded PTFE gasket, aligning the flanges using external means (e.g., come-along, chain-block).

(b) After each assembly, observe the gasket compression and measure the final thickness of the gasket after disassembly to demonstrate uneven loading when initial alignment of the flanges is not performed.

### A-2.4.3 Importance of Bolt Assembly Pattern

(a) Perform the following on a flange test rig having four or more bolts:

(1) Assemble a four-bolt, small-diameter flange with an expanded PTFE gasket without using a tightening pattern (i.e., using circular passes only).

(2) Assemble a four-bolt, small-diameter flange with an expanded PTFE gasket using a tightening pattern per ASME PCC-1.

(b) Observe gasket appearance, and measure the final thickness of the gasket after disassembly to demonstrate uneven loading when cross-pattern tightening is not used.

**A-2.4.4 Importance of Bolt Assembly Pattern and Correct Gasket Selection.** Perform the following test on a flange test rig having eight or more bolts ( $\geq$ NPS 6):

(a) Assemble a joint with a spiral-wound gasket without inner and outer rings, without using a tightening pattern (i.e., using circular passes only).

(b) Assemble a joint with a spiral-wound gasket with inner and outer rings, without using a tightening pattern (i.e., using circular passes only).

(c) Assemble a joint with a spiral-wound gasket without inner and outer rings, using a tightening pattern.

(d) Assemble a joint with a spiral-wound gasket with inner and outer rings, using a tightening pattern.

(e) After each assembly, carefully remove each of the above gaskets from the rig and inspect for damage to gasket sealing in the form of uneven compression or extrusion of the gasket windings.

**A-2.4.5 Reaction of Different Types of Gaskets to Standard Tightening Procedure.** Perform the following on a flange test rig having four or more bolts, with the capability to measure bolt load, stress, or elongation:

(a) Assemble a four-bolt, small-diameter flange with a spiral-wound gasket without inner and outer rings, using a tightening pattern, and ensure the gasket is centrally located on the raised face. Monitor the bolt load, stress, or elongation during the tightening to see when it stabilizes (number of passes).

(b) Repeat with a spiral-wound gasket with inner and outer rings.

(c) Repeat with a corrugated- or grooved-metal gasket that has graphite facing.

#### **A-2.4.6 Demonstration of the Effect of Lubricants.**

Perform tightening of a bolt using manual torque control with an instrumented bolt to measure the achieved bolt load.

(a) Assemble a bolt without lubricant to a torque value.

(b) Assemble the same bolt with lubricant to the same torque value.

(c) Compare the different achieved bolt loads.

#### **A-2.5 Duties**

The duties of a Qualified Bolting Specialist include the following:

(a) be able to assemble pressure vessel, piping, and tank bolted joints in accordance with all aspects of the training outlined in this Appendix

(b) be able to interpret and follow specific written joint assembly procedures

(c) provide guidance and assistance to trainee and bolting assemblers

(d) understand and complete correctly the joint assembly quality-assurance procedures and forms as required by his or her employer

(e) complete and ensure that the client receives appropriate documentation of joint assembly work [see para. A-2.3(s)]

#### **A-2.6 Maintenance and Renewal of Qualifications**

**A-2.6.1** To maintain the qualifications as a Qualified Bolting Specialist, an individual shall

(a) become familiar with the applications of new technology in gaskets, flanges, fasteners, assembly equipment, and joint assembly techniques.

(b) maintain knowledge of current local administrative or operating procedures necessary to discharge duties.

(c) maintain knowledge of the most recent revisions of ASME PCC-1 and other applicable standards, as listed in para. A-1.3.

(d) maintain awareness of new techniques and technologies in bolted joint assembly and disassembly.

(e) actively participate in selected meetings, seminars, and educational programs related to duties.

(f) have workplace access to the latest edition of ASME PCC-1 and the applicable documents referenced in para. A-1.3.

(g) attest to his or her compliance with (a) through (f) and provide at least two references from co-workers or his or her employer upon qualification and triennial renewal of qualification. At least one reference shall be from a supervisor at the individual's current or previous place of work.

**A-2.6.2** The Qualified Bolting Specialist shall take and pass the Training of Fundamentals portion (para. A-2.3) of the assessment in accordance with the requirements of the Qualification Program at least once every 3 yr to maintain his or her qualification.

**A-2.6.3** The Qualifying Organization is responsible for determining that the individual candidate is qualified (see section A-5).

### **A-3 REQUIREMENTS FOR QUALIFIED SENIOR BOLTING SPECIALISTS**

#### **A-3.1 Qualifications**

A Qualified Senior Bolting Specialist shall have received the training and practical experience, and shall possess the qualifications outlined in section A-2 for the Qualified Bolting Specialist. In addition, he or she shall

(a) have demonstrated aptitude for leadership, administration, and quality assurance.

(b) have demonstrated knowledge of the applicable standards and problems often found during joint assembly.

(c) have demonstrated ability to perform the administrative and technical duties described in para. A-3.2.

(d) have had at least 2 yr full-time experience (or the equivalent part-time experience, as defined in Table A-1) as a Qualified Bolting Specialist. Experience as a bolting assembler (in a job having a description that complies with the duties outlined in para. A-2.5) may be counted at one-half that obtained as a Qualified Bolting Specialist. The experience should be documented by references from senior bolting assemblers, Qualified Senior Bolting Specialists, or Qualified Bolting Specialist Instructors, indicating that the field experience obtained meets the requirements of this Appendix. An example reference sheet is supplied in Form A-1.

(e) have ready access to the latest edition of ASME PCC-1, as well as workplace access to the current editions of the documents referenced in para. A-1.3.

(f) take an active role in bolted-joint failure analysis and identification and implementation of corrective action at the company or plant sites where he or she is employed.

#### **A-3.2 Duties**

The duties of a Qualified Senior Bolting Specialist are identical to those of the Qualified Bolting Specialist (para. A-2.5) with the addition of those described in paras. A-3.2.1 and A-3.2.2.

**A-3.2.1 Administrative.** The administrative duties of a Qualified Senior Bolting Specialist, include, but are not limited to, the following:

(a) providing on-the-job training to bolting assemblers and bolting trainees

(b) maintaining and analyzing records, including those for joint assembly procedures, inspections, and Qualified Bolting Specialist performance, including meeting the requirements of section A-2

(c) ensuring that Qualified Bolting Specialists, bolting assemblers, and other personnel under his or her supervision perform their duties in accordance with the guidelines of ASME PCC-1 and all applicable site standards and requirements

(d) preparing joint assembly procedures in accordance with ASME PCC-1

(e) maintaining a workplace copy of the latest edition of ASME PCC-1, as well as the current edition of the documents referenced in para. A-1.3

**A-3.2.2 Technical.** The technical duties of a Qualified Senior Bolting Specialist include, but are not limited to, the following:

(a) reviewing assembly procedures and inspection reports, and ensuring enforcement of legally adopted requirements

(b) reviewing applications for waivers and variances, and making recommendations, as required, to proper authorities

(c) ensuring client review of joint assembly procedures and receipt of appropriate joint assembly documentation

(d) investigating complaints and accidents

(e) helping to develop company policies and procedures

(f) presenting on-site orientation courses for both Qualified Bolting Specialists and bolting assemblers

### A-3.3 Maintenance of Qualifications

**A-3.3.1** To maintain the qualifications, a Qualified Senior Bolting Specialist shall

(a) conform to the requirements of para. A-2.6.

(b) spend a minimum of 20% of time working in the field with Qualified Bolting Specialists, Qualified Senior Bolting Specialists, trained bolting assemblers, trained senior bolting assemblers, bolting assemblers, or senior bolting assemblers.

(c) assist with the amendment of existing work-site assembly procedures deemed inadequate or unsafe, or the development of revised work-site assembly procedures for unusual conditions or equipment.

(d) attest to his or her compliance with (a) through (c) and provide at least two references from co-workers or his or her employer upon qualification and triennial renewal of qualification. At least one reference should be from a supervisor at the individual's current or previous place of work.

**A-3.3.2** The Qualified Senior Bolting Specialist shall be required to renew their qualification at least once every 3 yr. The qualification renewal process shall include a statement of compliance with the requirements

of para. A-3.3.1 and shall include a short test or quiz designed to highlight any updates that have occurred in the preceding 3 yr to the Training of Fundamentals portion (para. A-2.3) of ASME PCC-1, Appendix A. If no changes to para. A-2.3 have occurred, then that portion of the requalification process may be omitted. The requalification process, test format, and test content shall be outlined in the Qualification Manual.

**A-3.3.3** The Qualifying Organization is responsible for determining that the individual candidate is qualified (see section A-5).

## A-4 REQUIREMENTS FOR QUALIFIED BOLTING SPECIALIST INSTRUCTORS

### A-4.1 Qualifications

A Qualified Bolting Specialist Instructor shall have received the training and practical experience and shall possess the qualifications outlined in section A-3 for the Qualified Senior Bolting Specialist and, in addition, shall

(a) have demonstrated aptitude for teaching, leadership, administration, and quality assurance.

(b) have demonstrated knowledge of the applicable codes and problems often found during joint assembly.

(c) have demonstrated ability to perform the administrative and technical duties in para. A-4.2.

(d) have at least 4 yr of full-time experience (or the equivalent part-time experience, as defined in Table A-1) as a Qualified Senior Bolting Specialist. Experience as a senior bolting assembler (in a job having a description that complies with the duties outlined in para. A-3.2) may be counted at one-third that obtained as a Qualified Senior Bolting Specialist. Experience as a bolting instructor (in a job having a description that complies with the duties outlined in para. A-4.2) may be counted at one-half that obtained as a Qualified Senior Bolting Specialist. The experience should be documented by references from senior bolting assemblers, Qualified Senior Bolting Specialists, or Qualified Bolting Specialist Instructors, indicating that the field experience obtained meets the requirements of this Appendix. An example reference sheet is supplied in Form A-1.

(e) have in his or her personal possession the latest edition of ASME PCC-1, as well as workplace access to the current editions of the documents referenced in para. A-1.3.

### A-4.2 Duties

The duties of a Qualified Bolting Specialist Instructor are identical to those of the Qualified Bolting Specialist (para. A-2.5) with the addition of those described in paras. A-4.2.1 and A-4.2.2.

**A-4.2.1 Administrative.** The administrative duties of a Qualified Bolting Specialist Instructor, include, but are not limited to, the following:

(a) providing on-the-job training to Qualified Bolting Specialists, bolting assemblers, and bolting trainees

(b) maintaining and analyzing records, including those for joint assembly procedures, inspections, and Senior Bolting Specialist performance, including meeting the requirements of section A-3

(c) ensuring that Senior Bolting Specialists under his or her supervision perform their duties in accordance with the requirements of section A-3

(d) preparing joint assembly procedures in accordance with the guidelines of ASME PCC-1

(e) maintaining a personal copy of the latest edition of ASME PCC-1, as well as having ready workplace access to the current edition of documents referenced in para. A-1.3

**A-4.2.2 Technical.** The technical duties of a Qualified Bolting Specialist Instructor include, but are not limited to, the following:

(a) reviewing assembly procedures and inspection reports, and ensuring enforcement of legally adopted requirements

(b) reviewing applications for waivers and variances, and making recommendations to proper authorities as required

(c) mediating disputes

(d) informally answering questions relating to ASME PCC-1, and submitting written requests for official interpretation, as required, to the secretary of the ASME Pressure Technology Post Construction Committee

(e) investigating complaints and accidents

(f) developing company policies and procedures, and advocating adoption of the latest national codes

(g) preparing and presenting training courses for both Qualified Bolting Specialists and nonqualified bolting assemblers

(h) preparing on-site orientation courses for both Qualified Bolting Specialists and nonqualified bolting assemblers

### A-4.3 Maintenance of Qualifications

**A-4.3.1** To maintain the qualifications, a Qualified Bolting Specialist Instructor shall

(a) conform to the requirements of para. A-3.3. and attend or conduct at least one professional-level seminar or workshop per year related to one or more of the duties described in para. A-4.2.

(b) spend a minimum of 10% of work time in the field with the Qualified Bolting Specialists, Qualified Senior Bolting Specialists, bolting assemblers, or senior bolting assemblers.

(c) attest to his or her compliance with (a) and (b) and provide at least two references from co-workers or his or her employer upon qualification and triennial

renewal of qualification. At least one reference is to be from a supervisor at the individual's current or previous place of work.

**A-4.3.2** The Qualified Bolting Specialist Instructor shall be required to renew their qualification at least once every 3 yr. The qualification renewal process shall include a statement of compliance with the requirements of para. A-4.3.1 and shall include a short test or quiz designed to highlight any updates that have occurred in the preceding 3 yr to the Training of Fundamentals portion (para. A-2.3) of this Appendix. If no changes to para. A-2.3 have occurred, then that portion of the qualification renewal process may be omitted. The qualification renewal process, test format, and test content shall be outlined in the Qualification Manual.

**A-4.3.3** The Qualifying Organization is responsible for determining that the individual candidate is qualified (see section A-5).

## A-5 QUALITY ASSURANCE

### A-5.1 Scope

This section provides recommended minimum requirements for a Qualification Manual that each Qualifying Organization should have. The Qualification Manual provides written documentation demonstrating compliance with this Appendix. The Qualifying Organizations should be subject to an initial and periodic review by an independent Review Organization for quality control purposes as described in this section.

### A-5.2 Qualification Manual

Organizations should have a Qualification Program that includes all those planned and systematic actions necessary to provide confidence that the requirements of this Appendix will be complied with. This program should be documented in a Qualification Manual, which should include a training course syllabus and example examination documents. The Qualification Manual shall be the basis for demonstration of compliance to the Review Organization. The Qualification Program should include the elements described in paras. A-5.2.1 through A-5.2.4.

#### A-5.2.1 Authority, Responsibility, Equipment, and Personnel

(a) The authority and responsibility of those in charge of the Qualification Program shall be clearly established and documented. They should have the organizational freedom and administrative and technical expertise necessary to implement the program.

(b) Personnel records should be maintained for all persons with a direct involvement in the program and should include the education, training, and experience of each person.

(c) The Qualifying Organization should maintain test and demonstration equipment capable of performing the practical examinations and demonstrations outlined in para. A-2.4. If additional supplemental qualifications (powered equipment, heat exchanger, or special joint) are offered by the organization, suitable equipment for the examination of those joint types is also required. In addition, the Qualifying Organization shall maintain sufficient joint assembly equipment on hand during theoretical training such that hands-on learning of the theory is possible.

**A-5.2.2 Methods of Evaluation of Qualification.** The Qualification Program should clearly delineate the method of evaluating whether applicants meet the requirements of Qualified Bolting Specialists (section A-2), Qualified Senior Bolting Specialists (section A-3), or Qualified Bolting Specialist Instructors (section A-4).

The methods of evaluation shall include, but are not limited to, the following:

- (a) written and/or oral examinations
- (b) practical examinations of joint assembly skill
- (c) verification of employment and field experience
- (d) verification of attendance or successful completion at educational institutions

The above methods shall demonstrate compliance with section A-2 for Qualified Bolting Specialists, section A-3 for Qualified Senior Bolting Specialists, or section A-4 for Qualified Bolting Specialist Instructors.

Means shall be provided to ensure that Qualified Bolting Specialists meet the maintenance of qualification provisions of para. A-2.6, that Qualified Senior Bolting Specialists meet the maintenance of qualification requirements of para. A-3.3, and that Qualified Bolting Specialist Instructors meet the maintenance of qualification requirements of para. A-4.3. The Qualification Program shall include provisions to detail how training, experience, examinations, a meeting, seminar, or education program can be accepted as meeting the criteria for maintenance of qualification. A list of currently approved training courses, experience, examination, meetings, seminars, and education programs should also be maintained on file. The information should be made known to all Qualified Bolting Specialists, Qualified Senior Bolting Specialists, and Qualified Bolting Specialist Instructors who are qualified by the Qualifying Organization.

**A-5.2.3 Revisions to Standards.** Provisions shall be included in the program to update it in conformance with revisions to ASME PCC-1 and to the reference standards listed in para. A-1.3. Copies of these standards shall be kept on file.

**A-5.2.4 International Qualifications.** Organizations that qualify persons as being qualified to assemble joints per this Appendix should supplement the training

requirements outlined in this Appendix with applicable regional, national, or international codes and standards.

### A-5.3 Procedures for Quality Control

**A-5.3.1 Application.** Qualifying Organizations should contract a suitable Review Organization to determine if the content of their program meets the requirements outlined in this Appendix.

**A-5.3.2 Selection of a Review Organization.** The Qualifying Organization should consider the impartiality and integrity of the Review Organization and also the qualifications of the SMEs used by the Review Organization when awarding the contract. Suitable Review Organizations may include insurance companies authorized to write boiler or pressure vessel insurance; recognized standards organizations qualified by ANSI or international, designated standards review bodies; industry organizations; or other similar impartial organizations.

**A-5.3.3 Evaluation of Qualification Program.** The Qualification Program should be evaluated by the Review Organization for compliance with this Appendix initially and at each review. The Qualification Manual should be the Review Organization's guide for reviewing the Qualifying Organization's continued compliance with the accepted Qualification Program.

**A-5.3.4 Qualifying Organization Reviews.** The Qualifying Organization should be subject to a periodic review by the Review Organization at least biannually.

**A-5.3.5 Portability of Qualifications.** The intent of the guidelines in this Appendix is to establish a basis for standard industry qualification of assemblers. Ideally, the qualification received by an assembler should be portable in nature. Portability achieves the following four goals:

- (a) The qualification has value to assemblers, as they may take it with them between jobs at different work sites.
- (b) It reduces the efforts required of each user, spreads the work of qualification across industry, and maximizes utilization and productivity of assemblers.
- (c) The user may rely on the holder of the qualification to have obtained, at a minimum, the level of competency as defined by the required training and experience outlined in this Appendix.
- (d) It assists users in evaluating the quality and level of experience of contract labor.

However, for those goals to be achieved, it may be necessary for users to accept varied Qualification Programs given by different Qualifying Organizations.

To achieve that level of acceptance, it is recommended that the users identify Review Organizations that maintain an acceptable level of SME knowledge and review ability to ensure that the requirements of para. A-5.3.3

are met to a level satisfactory to the user. Delegating the responsibility of quality review to independent Review Organizations maximizes the likelihood of portability being achieved; minimizes reliance on user resources; and allows endorsement of programs at the corporate, rather than site, level of the user organization.

Ideally, users will collaborate within international, national, regional, or industry groups to identify acceptable Review Organizations. This facilitates portability of qualification among those organizations and minimizes the likelihood that Qualifying Organizations will require more than one Review Organization to meet the requirements of the applicable users.

When a new Qualifying Organization seeks to be accepted by a user, it is recommended that the user primarily review and endorse the associated Review Organization, rather than each individual Qualifying Organization.

#### A-5.4 Definition of Terms

**A-5.4.1 Subject Matter Expert.** The objective in selecting the SMEs is to have a knowledge and experience base to provide a comprehensive review of the Qualification Manual.

(a) Selection of SMEs should be based on the following criteria:

(1) knowledge — possesses knowledge in the field of bolted joint assembly

(2) experience — has worked in the field of bolted joint assembly

(b) The following factors may be useful in selecting the SMEs:

(1) training — has documentation proving their successful completion of training programs in bolted joint assembly

(2) credentials and certifications — possesses applicable and appropriate credentials or certifications, or both, expected of an expert in bolted joint assembly

(3) experience — years of practical experience

**A-5.4.2 Balance of Knowledge.** The composition of the review team should include at least one of each of the following SMEs:

(a) an individual with sufficient experience and background to qualify as a Qualified Senior Bolting Instructor

(b) a mechanical or structural engineer with experience in the assembly, maintenance, and operation of bolted joints

(c) a mechanical or structural engineer with experience in the design and analysis of bolted joints

#### A-5.5 Program Effectiveness

To track the effectiveness of the Qualification Program offered, the Qualifying Organization should collect data from users, or their designees, regarding the success of the program.

For the purposes of this activity, it is suggested that success should be defined as a reduction in safety and environmental incidents related to bolted joint assembly. It is the responsibility of the Qualifying Organization and the Review Organization to define the process by which these measures are established and to define the criteria for determining success. The following suggested indicators of success are provided for guidance:

(a) percentage of qualified assemblers used in this period or project versus in previous periods or projects

(b) reduction or increase in the number of serious bolted-joint leakage incidents (involving injury or unit shutdown) compared to previous periods

(c) reduction or increase in the number of minor bolted-joint leakage incidents (not involving injury or unit shutdown) compared to previous periods

(d) reduction or increase in the number of injury incidents associated with bolted joint assembly

(e) percentage improvement in the apparent knowledge of the assemblers used versus previous periods or projects

(f) reduction or increase in the operational leak rates of bolted joints (if monitored) compared to previous periods

The data should be collected as a percentage increase or decrease. The data collected by this process should be provided to the Review Organization. The Review Organization should make such data public, to provide a means of evaluating the effectiveness of their review process.

## APPENDIX B

### DESCRIPTION OF COMMON TERMS

#### B-1 TIGHTENING TERMS

*four-bolting or eight-bolting*: the removal of every bolt except four or eight evenly spaced opposing bolts in preparation for breaking the joint (typically for blinding or valve removal) during a shutdown. The unit is offline to do this, as in the requirements for half bolting outlined in ASME PCC-2. However, as the joint is not broken, the line may still contain process fluid. There is a small risk of leakage with this procedure. This activity is performed to speed up blinding or valve removal during shutdown. An engineering and risk analysis of the four-bolting or eight-bolting operation should be carried out to establish that the operation can be performed safely.

*half bolting*: the removal of every other bolt (so the flange is left with half the number of bolts) during plant depressurization, usually when the system is close to atmospheric pressure. The procedure generally consists of removing every second bolt, relubricating them, reinstalling them, and retightening to a specified torque. The remaining bolts are then removed, relubricated, reinstalled, and retightened to a specified torque such that all bolts have been reinstalled. There is a small risk of leakage with this procedure, particularly if the system is accidentally repressurized. An engineering and risk analysis of the half-bolting operation should be carried out to establish that the operation can be performed safely. Refer to ASME PCC-2 for further information on joint-tightening activities once the unit is fully operational.

*hot bolting*: the sequential removal and replacement of bolts on flanged joints while the unit is under reduced operating pressure. The procedure generally consists of removing one bolt at a time in a flange, relubricating it, reinstalling it (or a new bolt), and retightening it to a specified torque. Hot boltings can be performed while the unit is online or once the unit is depressurized. If performed while the unit is online, consideration of the risk of leakage includes the number of bolts in the flange and the hazard associated with the contained process fluid. Hot bolting is used to either replace corroded or defective bolts or to proactively increase the gasket stress to prevent leakage (in high-temperature or cyclic services) or to reseal a small stable leak.

NOTE: Hot bolting while the unit is online to increase gasket stress or seal a small stable leak is not recommended or required if turn-of-nut tightening can be used. An engineering and risk

analysis of the hot-bolting operation should be carried out to establish that the operation can be performed safely. Refer to ASME PCC-2 for further information on joint-tightening activities once the unit is fully operational.

*hot torque*: see *start-up retorque*.

*live tightening*: tightening all bolts on a joint while the unit is operational or has been in operation for a period of time. The technique used for tightening may be manual torque, hydraulic torque, or hydraulic tension. However, torque can typically no longer be considered accurate after more than a few days of operation. Therefore, other techniques such as turn-of-nut or tensioning are preferred. Hot bolting is also an option, but there is a higher associated risk with that activity due to the associated reduction in gasket stress if the tightening is performed while the joint is pressurized. Live tightening should not be considered the same as start-up retorque, which is performed as part of the assembly operation; live tightening is an operational activity that may be performed on a periodic basis to recover relaxation (typically on high-temperature joints that have a history of leakage) or as a reaction to joint leakage. An engineering and risk analysis of the live-tightening operation should be carried out to establish that the operation can be performed safely. Refer to ASME PCC-2 for further information on joint-tightening activities once the unit is fully operational.

*odd-bolting*: see *half bolting*.

*online tightening*: see *live tightening*.

*start-up retorque*: tightening all bolts on a joint while the unit is coming up to operating temperature in a circular pass until the nuts no longer turn. Start-up retorque (also referred to as hot torque) is performed to increase the residual operational stress on the gasket (to recover initial gasket relaxation), to minimize the likelihood of leakage. It is typically performed while the unit is online but may also be performed prior to operation using heating pads to bring the flange up to temperature. Since this activity will only increase the load on the gasket, the risk of leakage is significantly lower than for other activities (such as hot bolting).

*turn-of-nut*: tightening all bolts on a joint while the unit is in operation or during a turnaround, without disassembling the joint. Turn-of-nut is used either to proactively increase the gasket stress to prevent leakage (in high-temperature or cyclic services) or to reseal a small stable leak. If this procedure is performed while the unit

is online, there is a small risk of additional leakage. However, since the load on the gasket will only increase, the risk of leakage is significantly lower than for other activities (such as hot bolting). Turn-of-nut involves tightening the joint by turning one nut on each bolt by a specific amount. Turn-of-nut does not require knowledge of the nut factor and therefore can be applied at any stage during the life of the joint. An engineering and risk analysis of the turn-of-nut operation should be carried out to establish that the operation can be performed safely. Turn-of-nut is used only for low-pressure, nonhazardous services if the gasket is a fiber-sheet gasket style, as that gasket type has a tendency to degrade in service and could blow out if retightened while operating.

## B-2 GASKET TERMS

*hard gaskets*: includes grooved-metal gaskets, corrugated-metal gaskets, and flat, solid-metal gaskets. Hard gaskets are typically defined as gaskets that have less than 1.0 mm (0.04 in.) compression during assembly. Generally speaking, it is not appropriate to classify gaskets as hard or soft based solely on physical hardness or softness of the gasket material itself. For example, 1.5-mm ( $\frac{1}{16}$ -in.) thick PTFE, flexible-graphite, or fiber gaskets are classified as hard gaskets. See also *hard-faced gaskets*.

NOTE: RTJ gaskets and lens gaskets are a special case and are addressed separately in sections D-3 and F-3.

*hard-faced gaskets*: gaskets that are constructed entirely from metal and do not have a soft filler material on the faces that come into contact with the flange seating

surfaces or have insufficient filler material to fill imperfections on the flange faces. It may not be acceptable to categorize by gasket type as extremely thin gaskets or gaskets without sufficient filler will not fill imperfections and therefore are categorized as hard-faced gaskets. Metal-faced gaskets, such as flat metal, RTJ, or double-jacketed gaskets, are categorized as hard-faced gaskets. See also *hard gaskets*.

*soft gaskets*: includes gaskets where the movement between the flange faces during assembly is relatively large, e.g., PTFE, spiral-wound, and compressed-fiber or flexible-graphite-sheet gaskets. Soft gaskets are typically defined as gaskets that have more than 1.0 mm (0.04 in.) compression during assembly. It is not appropriate to classify gaskets as hard or soft based solely on physical hardness or softness of the gasket material itself. For example, 1.5-mm ( $\frac{1}{16}$ -in.) thick PTFE, flexible-graphite, or fiber gaskets do not have sufficient compression to be classified as soft gaskets. See also *soft-faced gaskets*.

NOTE: RTJ gaskets and lens gaskets are a special case and are addressed separately in sections D-3 and F-3.

*soft-faced gaskets*: gaskets that are constructed from or have a soft filler material on the faces that come into contact with the flange seating surfaces. Soft-faced gaskets have sufficient soft filler (such as graphite, rubber, or PTFE) that both the gasket substrate and flange seating surface finish will be filled and additional filler exists on the gasket such that any small imperfections will also be filled as the gasket is compressed between the flanges. It may not be acceptable to categorize by gasket type as extremely thin sheet gaskets or gaskets without sufficient filler or facing will not fill imperfections and therefore are categorized as hard-faced gaskets. See also *soft gaskets*.



## APPENDIX C

# RECOMMENDED GASKET CONTACT SURFACE FINISH FOR VARIOUS GASKET TYPES

**Table C-1 Recommended Gasket Contact Surface Finish for  
Various Gasket Types**

Gasket Description	Gasket Contact Surface Finish [Note (1)]	
	$\mu\text{m}$	$\mu\text{in.}$
Spiral-wound	3.2–6.4	125–250
Soft-faced metal core with facing layers such as flexible graphite, PTFE, or other conformable materials	3.2–6.4	125–250
Flexible graphite reinforced with a metal interlayer insert	3.2–6.4	125–250
Grooved metal	1.6 max.	63 max.
Flat solid metal	1.6 max.	63 max.
Flat metal jacketed	2.5 max.	100 max.
Soft cut sheet, thickness $\leq 1.5$ mm ( $\frac{1}{16}$ in.)	3.2–6.4	125–250
Soft cut sheet, thickness $> 1.5$ mm ( $\frac{1}{16}$ in.)	3.2–13	125–500

**NOTE:**

(1) Finishes listed are average surface roughness values and apply to either the serrated concentric or serrated spiral finish on the gasket contact surface of the flange.

## APPENDIX D

# GUIDELINES FOR ALLOWABLE GASKET CONTACT SURFACE FLATNESS AND DEFECT DEPTH

### D-1 FLANGE FACE FLATNESS TOLERANCES

Existing industry flatness tolerance limits<sup>1</sup> do not include an assessment of the ability of the gasket to tolerate imperfections. The tolerances in Table D-1M/D-1 are dependent on the type of gasket employed and are categorized based on the initial axial compression of the gasket to the final assembled load.

Soft gaskets (see Appendix B) are more tolerant of flange flatness imperfections but are typically more difficult to assemble. Hard gaskets (see Appendix B) have less compression than soft gaskets and, while this can help with improved assembly due to less bolt interaction (cross-talk), it generally means that hard gaskets are more sensitive to flange flatness out-of-tolerance. It is suggested that load-compression test results for the gasket being used be obtained from the gasket manufacturer to determine which of the listed flatness tolerance limits should be employed.

It is acceptable to gauge mating flanges that have only one possible alignment configuration and determine that any waviness of the flange faces is complimentary, such that the seating surfaces follow the same pattern. This is found in multipass exchanger joints and is often caused by thermal distortion. In this case, it is conservative to calculate the overall gaps between the flanges at

<sup>1</sup> For example: PIP VESV1002, Design and Fabrication Specification for Vessels, ASME Boiler and Pressure Vessel Code Section VIII, Divisions 1 and 2 (March 2012), para. 4.4.3.13; and API 660, 8th ed., Table 3.

points around the circumference and utilize the single-flange tolerances as shown in Table D-1M/D-1 to determine acceptability of the gap.

### D-2 FLANGE FACE IMPERFECTION TOLERANCES

The tolerances shown in Table D-2M/D-2 are separated into two categories, depending on the gasket being employed in the joint (see Appendix B). Care should be taken to ensure the correct tolerances are employed for the gasket being installed. It is important to note that the tolerances apply to the gasket seating surface (area where the gasket seats both initially and finally after assembly).

### D-3 RTJ GASKETS

Flanges for RTJ gaskets are typically inspected for flange flatness and seating surface imperfections in a different manner than that for raised-face flanges. The flange flatness and groove dimensions are examined prior to joint disassembly by inspection of the gap between the outer edges of the raised faces. If the gap at any location around the joint circumference is less than 1.5 mm (0.0625 in.), then consideration should be given to repair or remachining of the groove at the next opportunity. This eliminates the risk of the flange faces touching during assembly, which can lead to joint leakage. Once the joint is disassembled, the gasket seating surface (see Fig. D-5) should be inspected for damage in accordance with the requirements listed for hard gaskets in Table D-2M/D-2.

**Table D-1M Flange Seating Face Flatness Tolerances (Metric)**

Measurement	Hard Gaskets	Soft Gaskets
Acceptable variation in circumferential flange seating surface flatness	$T1 < 0.15 \text{ mm}$	$T1 < 0.25 \text{ mm}$
Acceptable variation in radial (across surface) flange seating surface flatness	$T2 < 0.15 \text{ mm}$	$T2 < 0.25 \text{ mm}$
Maximum acceptable pass-partition surface height vs. flange face	$-0.25 \text{ mm} < P < 0.0 \text{ mm}$	$-0.5 \text{ mm} < P < 0.0 \text{ mm}$

GENERAL NOTE: See Figs. D-1 and D-2 for description of  $T1$  and  $T2$  measurement methods.

**Table D-1 Flange Seating Face Flatness Tolerances (U.S. Customary)**

Measurement	Hard Gaskets	Soft Gaskets
Acceptable variation in circumferential flange seating surface flatness	$T1 < 0.006 \text{ in.}$	$T1 < 0.01 \text{ in.}$
Acceptable variation in radial (across surface) flange seating surface flatness	$T2 < 0.006 \text{ in.}$	$T2 < 0.01 \text{ in.}$
Maximum acceptable pass-partition surface height vs. flange face	$-0.010 \text{ in.} < P < 0.0 \text{ in.}$	$-0.020 \text{ in.} < P < 0.0 \text{ in.}$

GENERAL NOTE: See Figs. D-1 and D-2 for description of  $T1$  and  $T2$  measurement methods.

**Fig. D-1 Flange Circumferential Variation Tolerance,  $T1$** 

Align the measurement tool and set the datum at four points around the circumference. Take measurements around the full circumference to compare to tolerance  $T1$ . Increment out 6 mm (0.25 in.) and repeat measurement. Repeat until entire gasket seating surface (grey region) has been measured.

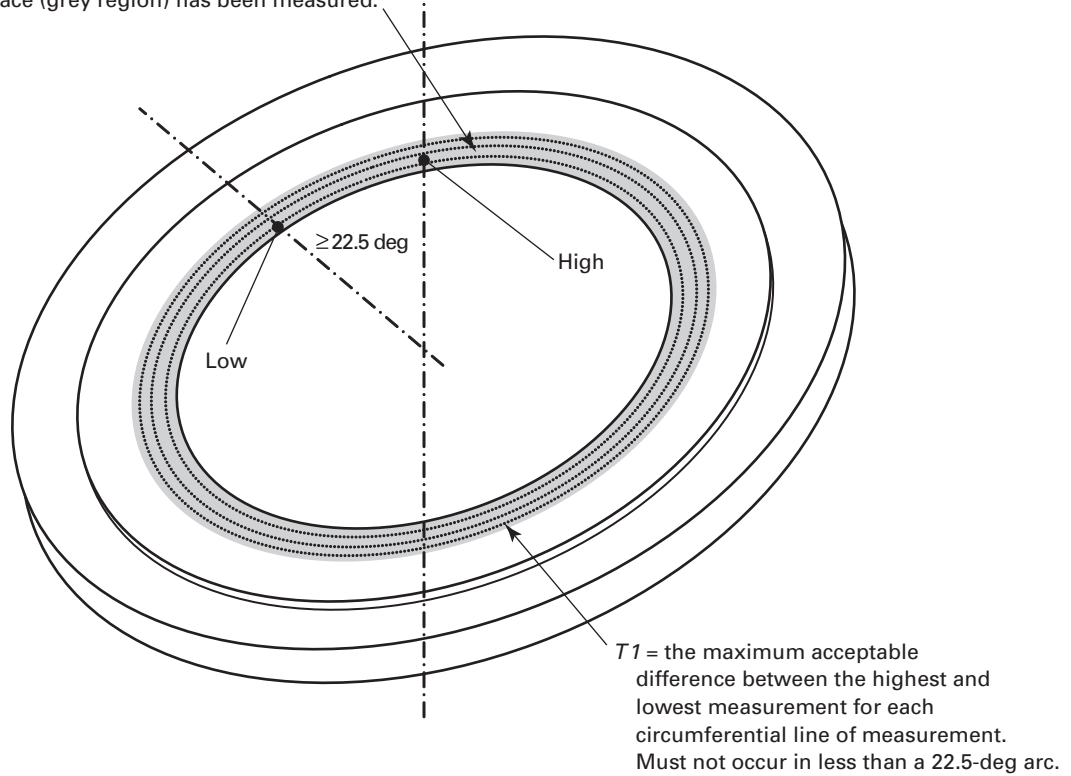

**Fig. D-2 Flange Radial Variation Tolerance,  $T_2$**

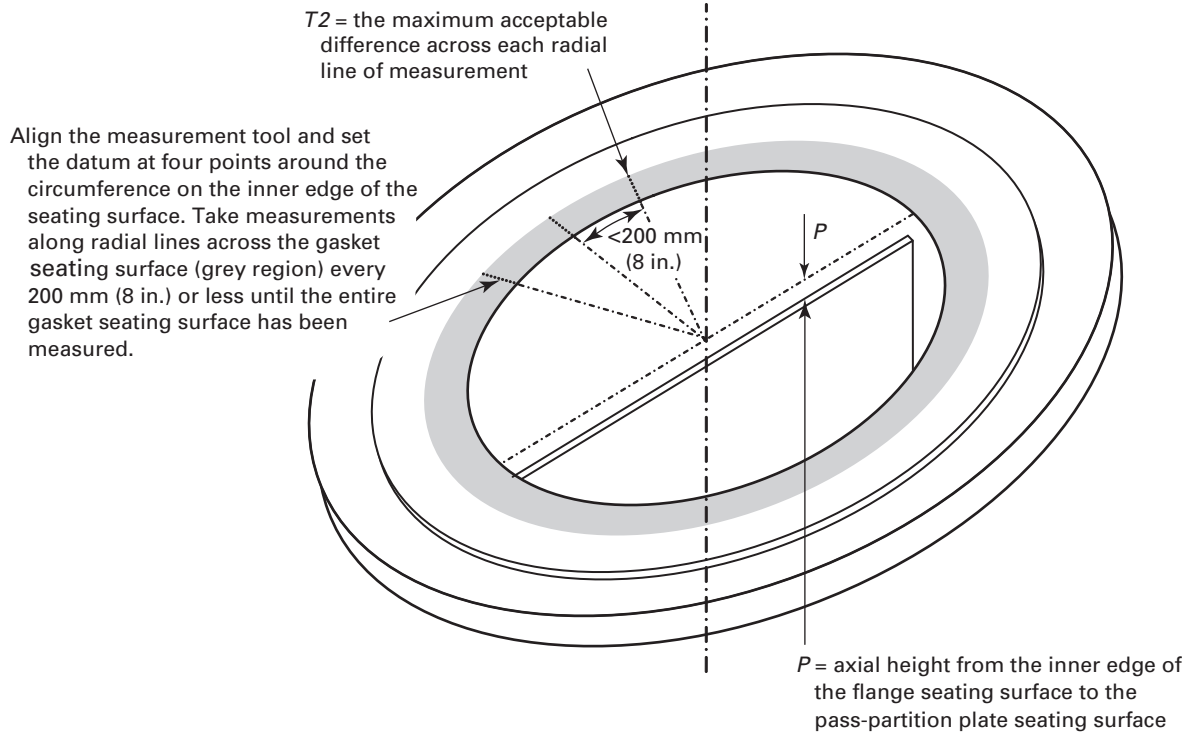

**Table D-2M Allowable Defect Depth vs. Width Across Face (Metric)**

Measurement	Hard-Faced Gaskets	Soft-Faced Gaskets
$r_d < w/4$	< 0.76 mm	< 1.27 mm
$w/4 < r_d < w/2$	< 0.25 mm	< 0.76 mm
$w/2 < r_d < 3w/4$	Not allowed	< 0.13 mm
$r_d > 3w/4$	Not allowed	Not allowed

GENERAL NOTES:

- (a) See Figs. D-3 and D-4 for description of defect measurement and for definition of  $w$ .
- (b) Defect depth is measured from the peak of the surface finish to the bottom of the defect.

**Table D-2 Allowable Defect Depth vs. Width Across Face (U.S. Customary)**

Measurement	Hard-Faced Gaskets	Soft-Faced Gaskets
$r_d < w/4$	< 0.030 in.	< 0.050 in.
$w/4 < r_d < w/2$	< 0.010 in.	< 0.030 in.
$w/2 < r_d < 3w/4$	Not allowed	< 0.005 in.
$r_d > 3w/4$	Not allowed	Not allowed

GENERAL NOTES:

- (a) See Figs. D-3 and D-4 for description of defect measurement and for definition of  $w$ .
- (b) Defect depth is measured from the peak of the surface finish to the bottom of the defect.

**Fig. D-3 Flange Surface Damage Assessment: Pits and Dents**

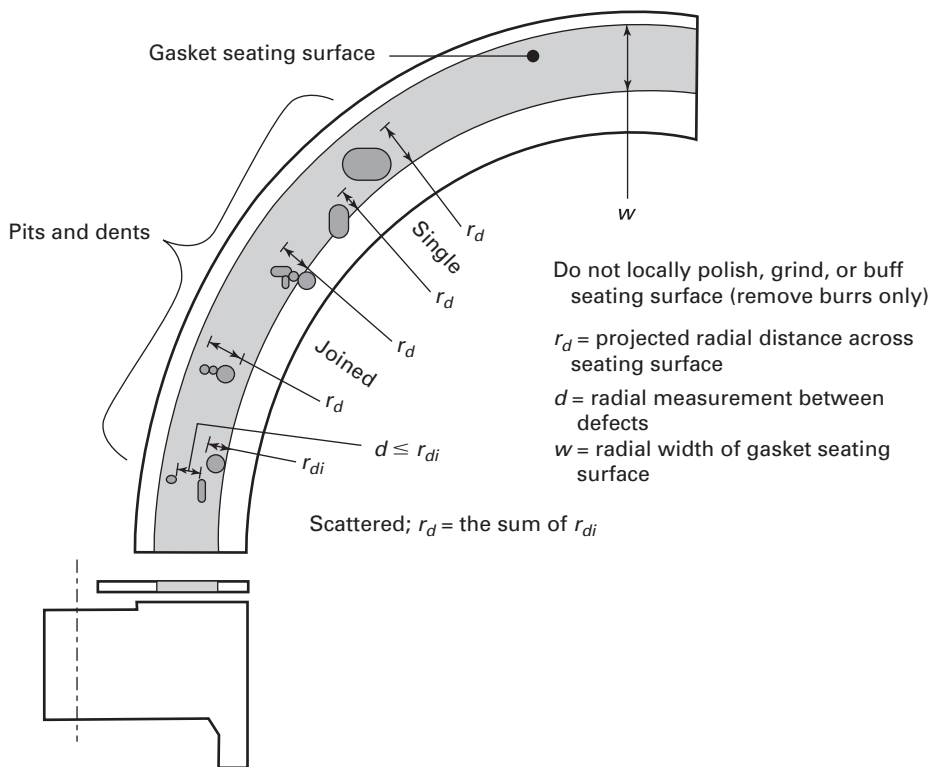

**Fig. D-4 Flange Surface Damage Assessment: Scratches and Gouges**

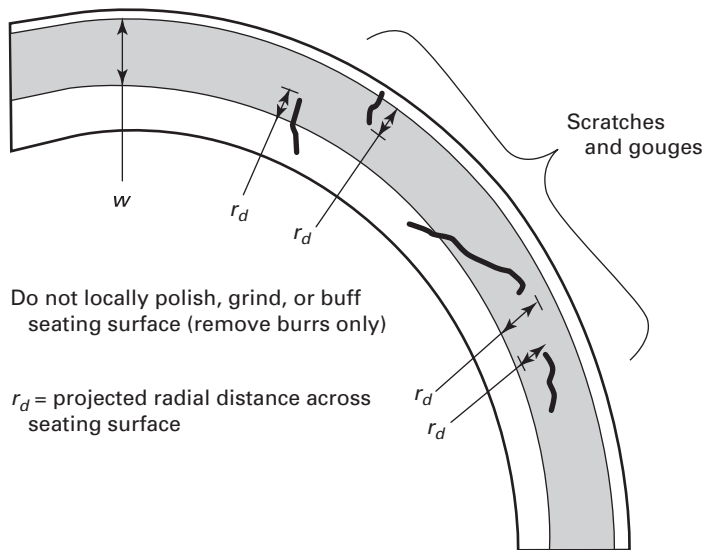

**Fig. D-5 RTJ Gasket Seating Surface Assessment**

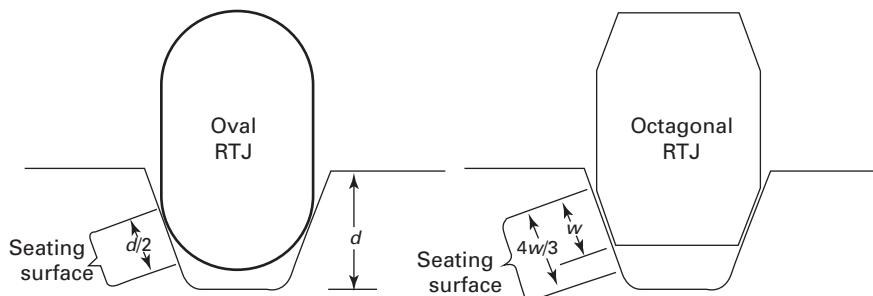

# APPENDIX E

## FLANGE JOINT ALIGNMENT GUIDELINES

### E-1 GENERAL

Proper alignment of all joint members is the essential element of flange joint assembly. It results in maximum seating surface contact, maximum opportunity for uniform gasket loading, and improves the effectiveness of all bolt tightening methods. The following guidelines apply for aligning mating flanges.

### E-2 GUIDELINES FOR ALIGNING FLANGES

(a) Out-of-tolerance conditions should be corrected before the gasket is installed to avoid damaging it. Only minimum or reasonable adjustments should be made after the gasket is installed.

(b) When aligning requires more force than can be exerted by hand or common hand and hammer alignment tools such as spud wrenches and alignment pins, consult an engineer.

(c) Proper alignment will result in the bolts passing through the flanges at right angles and the nuts resting flat against the flanges prior to tightening.

(d) Before using jacks or wrench devices, a pipe stress analysis may be appropriate, especially if the pipe is old or it is suspected that the walls have thinned from use.

(e) If the flanges that are in need of aligning are connected to pumps or rotating equipment, great care must be taken to prevent introducing a strain into the equipment housing or bearings. Measuring the movement in the equipment to ensure that its aligned condition is not disturbed is a common and necessary practice. (See "parallelism" and "rotational-two hole" under para. E-2.4.)

(f) The best practice is to repair the misaligned component by replacing it correctly, removing and reinstalling it in the properly aligned position, or using uniform heat to relieve the stresses.

(g) In joints where one or more of the flanges are not attached to piping or vessels, such as cover plates and tube bundles, use ample force to accomplish the best aligned condition.

(h) Once the flanges are aligned, install the gasket and tighten the fasteners completely, and then release the aligning devices. Follow this rule as closely as possible. External forces have less effect on properly loaded joints.

### E-2.1 Large Piping Connected to Load-Sensitive Equipment

It is recognized that more stringent alignment tolerances may be required for large piping connected to load-sensitive equipment such as machinery. For machinery, refer to API Recommended Practice 686, Chapter 6, Sections 4.6 through 4.9 and Fig. B-4.

### E-2.2 Critically Stiff Piping System

Stringent alignment tolerance guidelines that apply to a critically stiff piping system such as may be connected to a pump or other rotating equipment nozzle are covered in paragraph 1.2.2 of WRC Bulletin 449 (Guidelines for the Design and Installation of Pump Piping Systems). This guideline accounts for the stiffness of the system and is based on misalignment not causing more than 20% of the pump nozzle allowable loading. Where rotating equipment is not involved a tolerance 4 times as large may be considered.

### E-2.3 Stiff or Troublesome Piping Systems

For very stiff or troublesome piping systems larger than DN 450 (NPS 18), it may be beneficial and more economical to consider the special guidelines of paragraph 1.2.3 of WRC Bulletin 449 concerning the modification or rebuilding of a portion of the system to assure acceptable alignment.

### E-2.4 Terms and Definitions

*centerline high/low*: the alignment of piping or vessel flanges so that the seating surfaces, the inside diameter of the bore, or the outside diameter of the flanges match or meet with the greatest amount of contact surface.

Tolerance is usually measured by placing a straight edge on the outside diameter of one flange and extending it to or over the mating flange. This is done at four points around the flange, approximately 90 deg from each other. The tolerance is 1.5 mm ( $\frac{1}{16}$  in.) at any point (see Fig. E-1).

*parallelism*: the alignment of piping or vessel flanges so that there are equal distances between the flange faces at all points around the circumference of the joint, therefore making the flange faces parallel to each other.

The tolerance is usually determined by measuring the closest and farthest distance between the flanges and comparing. An acceptable practice is a difference no greater than 0.8 mm ( $\frac{1}{32}$  in.) at the O.D. of the sealing



surface, achieved using a force of no greater than 10% of the maximum torque or bolt load for any bolt (see Fig. E-2).

*rotational-two hole:* the alignment of piping or vessel flanges so that the bolt holes align with each other, allowing the fasteners to pass through perpendicular to the flanges.

The tolerance is measured by observing a 90-deg angle where the fastener passes through the flanges or the holes are within 3 mm ( $\frac{1}{8}$  in.) of perfect alignment (see Fig. E-3).

*excessive spacing or gap:* a condition where two flanges are separated by a distance greater than twice the thickness of the gasket when the flanges are at rest and the

flanges will not come together using reasonable force (see Fig. E-4).

When no external alignment devices are used, the flanges should be brought into contact with the uncompressed gasket uniformly across the flange faces using less than the equivalent of 10% of the total target assembly bolt load. When aligning the flanges, no single bolt should be tightened above 20% of the single bolt maximum torque or target bolt load.

When external alignment devices are used, the flanges should be brought to the compressed gasket thickness uniformly across the flange faces using an external load equivalent to less than 20% of the total target assembly bolt load.

If more force is required to bring the flange gap into compliance, consult an engineer.

**Fig. E-1 Centerline High/Low**

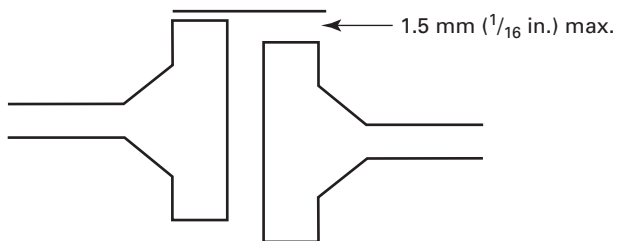

GENERAL NOTE: See para. E-2.4.

**Fig. E-2 Parallelism**

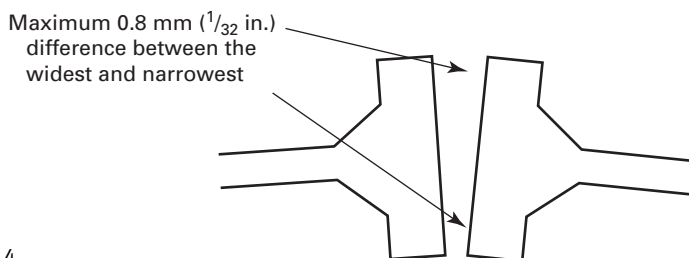

GENERAL NOTE: See para. E-2.4.

**Fig. E-3 Rotational-Two Hole**

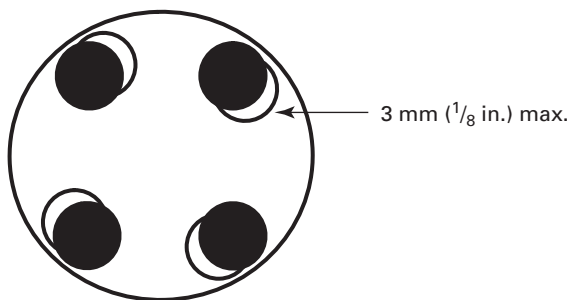

**Fig. E-4 Excessive Spacing or Gap**

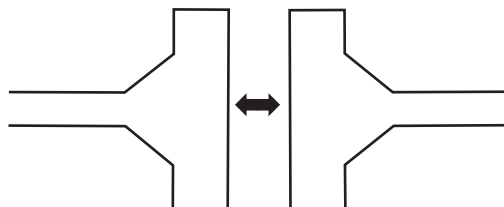

GENERAL NOTE: See para. E-2.4.

## APPENDIX F

# ALTERNATIVES TO LEGACY TIGHTENING SEQUENCE/PATTERN

### F-1 EXISTING PROCEDURES

In recent years, there has been successful implementation of joint assembly patterns and torque-increment combinations that require less assembly efforts than the ASME PCC-1 Legacy method and, for certain gaskets, these procedures may actually improve the resulting gasket stress and compression distribution versus the Legacy method. These alternative procedures have received wide acceptance for their performance and are presented (along with the limitations for their application) to offer the user alternatives to the Legacy method. A summary of the procedures is presented in Table F-1. It is recommended that the user carefully evaluate any alternative procedure prior to implementing its use on pressure equipment and ensure its applicability and performance. Users should critically review the following cautions and concerns with utilization of any alternative, non-Legacy, assembly procedure:

- (a) localized over-compression of the gasket
- (b) uneven tightening resulting in flange distortion
- (c) nonuniform application of gasket seating load
- (d) excessive load/unload of the gasket during assembly
- (e) resulting nonparallel flanges

NOTE: Each of the assembly patterns discussed in this Appendix involves incremental tightening in steps that are expressed as percentages of Target Torque (the torque calculated to produce the final desired load or clamping force in the joint). The percentage values assigned to these intermediate steps are approximate and not exact, as their purpose is to promote even and gradual application of load, and to avoid conditions which might irreparably damage a gasket. Even the Target Torque numbers should be looked upon as the center of an acceptable range, and not as absolute point values (section 12). Within each Pass, intermediate or final, consistency and gradual application of load around the joint is the goal. The term "Target Torque" should not be taken to imply that the assembly patterns listed here are applicable only to torque control methods of assembly. The patterns are also applicable to other methods of joint assembly, such as tension and uncontrolled. Assembly of flanges with a large number of bolts will benefit from grouped bolting (tightening groups of three or four bolts). Refer to Table 4.

The Legacy pattern/numbering system is illustrated in Fig. F-1 for a 24-bolt joint for use in comparing it with the single-tool alternative procedures that follow. Depending upon the number of bolts on the flange, bolt grouping should be employed, and the groups may be tightened as though they were individual bolts.

Alternative Assembly Patterns #1, #2, and #3 are provided for single-bolt tightening, whereas Alternative Assembly Procedures #4 and #5 are provided for two- and four-bolt simultaneous tightening, respectively.

#### F-1.1 Alternative Assembly Pattern #1

This pattern uses the same pattern as the Legacy method; however, the stress levels are increased more rapidly, which allows fewer pattern Passes to be performed and less overall effort. For example, on a 24-bolt flange, the use of Alternative Pattern #1 requires a minimum of 72 tightening actions as opposed to 120 for the Legacy pattern. This method has been successfully applied in limited applications across the full range of gaskets and joint configurations.

Tightening sequence for Pattern #1 is described in (a) through (d) below. An example is provided in Fig. F-2. A step-by-step example is shown in Fig. F-7.

(a) Pass #1a: Proceed in the pattern outlined in Fig. F-2 and tighten the first four bolts at 20% to 30% of Target Torque.

(b) Pass #1b: Tighten the next four bolts at 50% to 70% of Target Torque.

(c) Passes #1c and #2: Tighten all subsequent bolts at 100% of Target Torque until all pattern Passes are complete.

(d) Pass #3 onward: Tighten in circular Passes until the nuts no longer turn.

For soft gaskets,<sup>1</sup> a minimum of two pattern Passes are required.

For hard gaskets,<sup>1</sup> a minimum of one pattern Pass is required.

For problematic joints, it is recommended that an additional pattern Pass be completed above the minimum required.

#### F-1.2 Alternative Assembly Pattern #2

This pattern uses a modified bolting pattern that is simpler to follow than the Legacy pattern and does not require the assembler to mark the bolt numbers on the flange, as the next loose bolt in any given quadrant will always be the next bolt to tighten. Pattern #2A of Fig. F-3 follows a star pattern, whereas Pattern #2B applies the load in a circular manner. Figure F-8 presents a step-by-step example of Pattern #2A. This method has been successfully applied in limited applications across the

<sup>1</sup> Soft and hard gaskets are described in Appendix B.

**Table F-1 Summary Instruction on the Use of Alternative Assembly Procedures**

Method	Application	First Action	Second Action	Third Action	Fourth Action	Fifth Action	Notes
Legacy STAR PATTERN	All bolted, flanged connections	All bolts, <i>star pattern</i>	All bolts, <i>star pattern</i>	All bolts, <i>star pattern</i>	All bolts, <i>circular pattern</i>	All bolts, <i>circular pattern</i> , until no further nut movement	This assembly procedure has been successfully applied throughout industry for all gasket styles and flange types. It is the standard "Best Practices" assembly procedure for bolted, flanged connections.
Percent of Final Torque		30%	70%	100%	100%	100%	
Alternative Pattern #1	The same as the Legacy pattern, however the stress levels are increased more rapidly, allowing fewer pattern passes to be performed and less overall effort. This method has been successfully applied in limited applications across the full range of gaskets and joint configurations.	First four to six bolts, <i>star pattern</i>	Next four to six bolts, <i>star pattern</i>	Remaining bolts, <i>star pattern</i>	All bolts, <i>star pattern</i>	All bolts, <i>circular pattern</i> , until no further nut movement	For soft gaskets (see Appendix B), a minimum of two pattern passes are required. For hard gaskets (see Appendix B), a minimum of one pattern pass is required. For problematic joints, it is recommended that an additional pattern pass be completed above the minimum required.
Percent of Final Torque		30%	70%	100%	100%	100%	
Alternative Pattern #2: QUADRANT PATTERN	A modified pattern that is simpler to follow than the Legacy pattern and does not require bolt numbers on the flange to be marked, as the next loose bolt in any given quadrant will always be the next bolt to tighten. Successfully applied in limited applications across the full range of gaskets and joint configurations commonly found in refining industry.	First four bolts, <i>star</i> or <i>circular</i> sequence	Index one bolt from start, then next four bolts, <i>star</i> or <i>circular</i> sequence	Index two bolts from start, then remaining bolts indexing another bolt each pass, <i>star</i> or <i>circular</i> sequence	All bolts, <i>star</i> or <i>circular</i> sequence	All bolts, <i>circular pattern</i> , until no further nut movement	For soft gaskets (see Appendix B), a minimum of two pattern passes are required. For hard gaskets (see Appendix B), a minimum of one pattern pass is required. For problematic joints, additional pattern pass should be completed above the minimum required.
Percent of Final Torque		20% to 30%	50% to 70%	100%	100%	100%	

**Table F-1 Summary Instruction on the Use of Alternative Assembly Procedures (Cont'd)**

Method	Application	First Action	Second Action	Third Action	Fourth Action	Fifth Action	Notes
Alternative Pattern #3: CIRCULAR PATTERN	This bolting pattern tightens only four bolts in a pattern to bring the joint into alignment, prior to commencing the circular passes. It is easy, does not require the assembler to mark the bolt numbers, and requires less effort for the overall tightening process. This method has been successfully applied in limited applications across the harder gaskets (see Appendix B) in joint configurations commonly found in refining applications.	12:00 6:00 3:00 9:00 bolts  <i>Star pattern</i>	12:00 6:00 3:00 9:00 bolts  <i>Star pattern</i>	12:00 6:00 3:00 9:00 bolts  <i>Star pattern</i>	All bolts, <i>circular pattern</i> , until no further nut movement		For hard gaskets (see Appendix B), a minimum of one pattern pass is required. For problematic joints, it is recommended that an additional pattern pass be completed above the minimum required. This procedure has been approved by the Japanese Industrial Standards Committee. Analysis has shown it also be suitable for soft materials such as spiral-wound and fiber-sheet gasket types.
Percent of Final Torque		20% to 30%	50% to 70%	100%	100%		
Alternative Pattern #4: SIMULTANEOUS MULTIBOLT PATTERN (4 Tools) More than four tools can be used, always maintaining even spacing of tools around the flange	Eliminates the need for pattern passes. At least four bolts are tightened simultaneously. Flange alignment is ensured without the need for tightening patterns. It is simpler, does not require the assembler to mark the bolt numbers, and requires less effort. Requires an automatable tightening process, such as hydraulic torque or tension. This method has been successfully applied in applications across the full range of gaskets and joint configurations commonly found in refining and petrochemical applications.	12:00 3:00 6:00 9:00 bolts	Split the angles between tightened bolts until approx. one-fourth of bolts are at 50% of Target Torque	Return to start. Tighten all bolts in groups of four at 90 deg from one another to 100% of Target Torque	Complete a circular "check pass" moving the four tools a bolt at a time at 100% until no nut movement		Purpose of 50% initial tightening of about one-fourth of the bolts is to ensure parallel alignment, seat gasket, and avoid non-recoverable errors. Purpose of splitting the angles is to avoid potential "wrinkling" of the gasket or flange. Critical applications may justify a tool on every bolt. In this case, all bolts should be tightened simultaneously to 100% of target torque. No check pass is then required.
Percent of Final Torque		50%	50%	100%	100%		

**Table F-1 Summary Instruction on the Use of Alternative Assembly Procedures (Cont'd)**

Method	Application	First Action	Second Action	Third Action	Fourth Action	Fifth Action	Notes
Alternative Pattern #5:		Two bolts, 180 deg apart (N-S), simultaneously at 30% full torque, then tighten two bolts 180 deg apart indexed 90 deg (E-W) at 30% full torque	Same two bolts, 180 deg apart (N-S), simultaneously at 60% full torque, then tighten two bolts 180 deg apart indexed 90 deg (E-W) at 60% full torque	Same two bolts, 180 deg apart (N-S), simultaneously at 100% full torque, then tighten two bolts 180 deg apart indexed 90 deg (E-W) at 100% full torque	Dual tool circular tightening at 100% full torque until no further nut movement		Assembly procedure developed and field qualified in the chemical industry for thin flanges and soft gaskets. Column body flanges in particular.
SIMULTANEOUS MULTIBOLT TIGHTENING COMBINED WITH A CIRCULAR PATTERN (2 or More Tools)							
Percent of Final Torque		20% to 30%	50% to 70%	100%	100%		

**Fig. F-1 Legacy Pattern Numbering System**

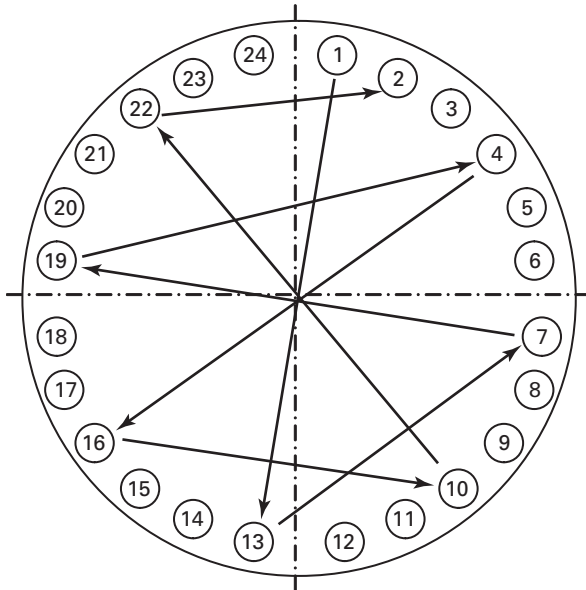

**Fig. F-2 Alternative Assembly Pattern #1 (Modified Legacy Pattern)**

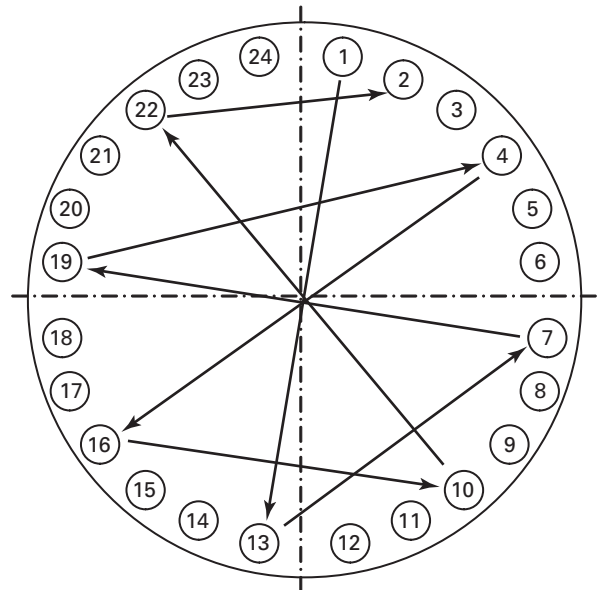

**GENERAL NOTES:**

- (a) Pass 1 – 20% to 30% of Target Torque  
1,13,7,19 – 4,16,10,22 – 2,14,8,20 – 5,17,11,23 – 3,15,9,21 – 6,18,12,24
- (b) Pass 2 – 50% to 70% of Target Torque  
Same pattern as Pass 1.
- (c) Pass 3 – 100% of Target Torque  
Same pattern as Pass 1.
- (d) Pass 4 – 100% of Target Torque, in circular pattern, until nuts do not turn. 1,2,3,4,5,6,7,8,9,10,11,12,13,14,15,16,17,18,19, 20,21,22,23,24 – 1,2,3,etc.
- (e) Pass 5 (optional) – 100% of Target Torque (performed 4 h after Pass 4), in circular pattern, until nuts do not turn.

**GENERAL NOTES:** The following is a 24-bolt example of a tightening sequence for Pattern #1:

- (a) Pass 1a – 20% to 30% of Target Torque: 1,13,7,19
- (b) Pass 1b – 50% to 70% of Target Torque: 4,16,10,22
- (c) Pass 1c – 100% of Target Torque: 2,14,8,20 – 5,17,11,23 – 3,15,9,21 – 6,18,12,24
- (d) Pass 2 (If second pattern pass specified) – 100% of Target Torque 1,13,7,19 – 4,16,10,22 – 2,14,8,20 – 5,17,11,23 – 3,15,9,21 – 6,18,12,24
- (e) Pass 3 onward – 100% of Target Torque, in circular pattern, until nuts do not turn. 1,2,3,4,5,6,7,8,9,10,11,12,13,14,15, 16,17,18,19,20,21,22,23,24 – 1,2,3, etc.

**Fig. F-3 Alternative Assembly Pattern #2 (Quadrant Pattern)**

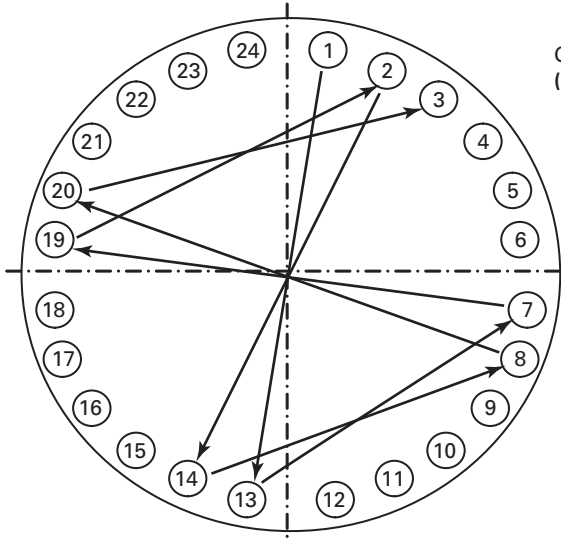

**2A: Star Sequence**

**GENERAL NOTES:**

**(1) 24-Bolt Example — Star Sequence:**

**(a) Pass 1a** — 20% to 30% of Target Torque: 1,13,7,19

**(b) Pass 1b** — 50% to 70% of Target Torque: 2,14,8,20

**(c) Pass 1c** — 100% of Target Torque: 3,15,9,21 – 4,16,10,22 – 5,17,11,23 – 6,18,12,24

**(d) Pass 2 (If second pattern Pass specified)** — 100% of Target Torque: 1,13,7,19 – 2,14,8,20 – 3,15,9,21 – 4,16,10,22 – 5,17,11,23 – 6,18,12,24

**(e) Pass 3 onward** — 100% of Target Torque (until nuts do not turn): 1,2,3,4,5,6,7,8,9,10,11,12,13,14,15,16,17,18,19,20,21,22,23,24 – 1,2,3, etc.

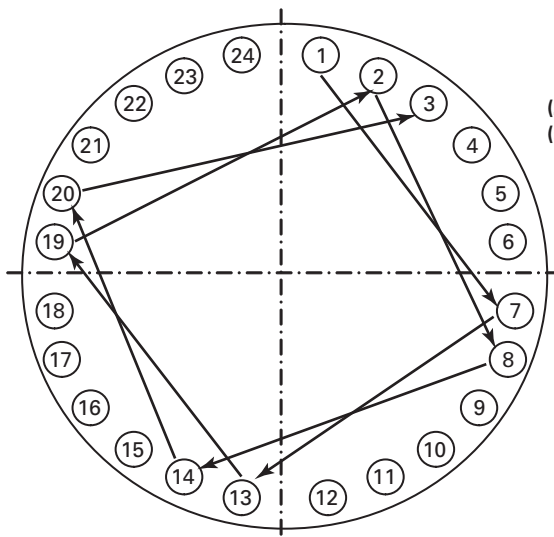

**2B: Circular Sequence**

**(2) 24-Bolt Example — Circular Sequence (suitable only for >16-bolt flanges):**

**(a) Pass 1a** — 20% to 30% of Target Torque: 1,7,13,19

**(b) Pass 1b** — 50% to 70% of Target Torque: 2,8,14,20

**(c) Pass 1c** — 100% of Target Torque: 3,9,15,21 – 4,10,16,22 – 5,11,17,23 – 6,12,18,24

**(d) Pass 2 (If second pattern Pass specified)** — 100% of Target Torque: 1,7,13,19 – 2,8,14,20 – 3,9,15,21 – 4,10,16,22 – 5,11,17,23 – 6,12,18,24

**(e) Pass 3 onward** — 100% of Target Torque (until nuts do not turn): 1,2,3,4,5,6,7,8,9,10,11,12,13,14,15,16,17,18,19,20,21,22,23,24 – 1,2,3, etc.



full range of gaskets and joint configurations commonly found in refining applications.

Tightening sequence for Pattern #2 is described in (a) through (d) below.

(a) Pass #1a: Proceed in one of the Fig. F-3 patterns and tighten the first four bolts to 20% to 30% of Target Torque.

(b) Pass #1b: Tighten the next four bolts at 50% to 70% of Target Torque.

(c) Passes #1c and #2: Tighten all subsequent bolts at 100% of Target Torque until all pattern Passes are complete.

(d) Pass #3 onward: Tighten in circular Passes until the nuts do not turn.

For soft gaskets,<sup>1</sup> a minimum of two pattern Passes is required.

For hard gaskets,<sup>1</sup> a minimum of one pattern Pass is required.

For problematic joints, it is recommended that an additional pattern Pass be completed above the minimum required.

### F-1.3 Alternative Assembly Pattern #3

This bolting pattern initially tightens only four bolts to bring the joint into alignment and begin seating the gasket, prior to commencing the circular Passes. It is much simpler, does not require the assembler to mark the bolt numbers, and requires less effort as the tightening sequence reduces movement from one side of the flange to the other. This method has been successfully applied in limited applications utilizing harder gaskets in joint configurations commonly found in refining applications, and has been qualified in experimental evaluations as suitable for spiral-wound and fiber-sheet gasket types.<sup>2</sup>

Tightening sequence for Pattern #3 is described in (a) through (d) below. An example is provided in Fig. F-4. A step-by-step example is shown in Fig. F-9.

(a) Pass #1a: Proceed in the pattern outlined in Fig. F-4 and tighten four bolts, equally spaced at 90 deg apart, to 20% to 30% of Target Torque.

(b) Pass #1b: Tighten the same four bolts to 50% to 70% of Target Torque.

(c) Pass #1c: Tighten the same four bolts to 100% of Target Torque.

(d) Pass #1d onward: Tighten in circular Passes at 100% of Target Torque until the nuts no longer turn.

### F-1.4 Alternative Assembly Pattern #4: Simultaneous Multibolt Tightening Pattern (Group Numbering System)

The simultaneous use of multiple tools spaced evenly around a flange has been shown to give equal or even

**Fig. F-4 Alternative Assembly Pattern #3 (Circular Pattern)**

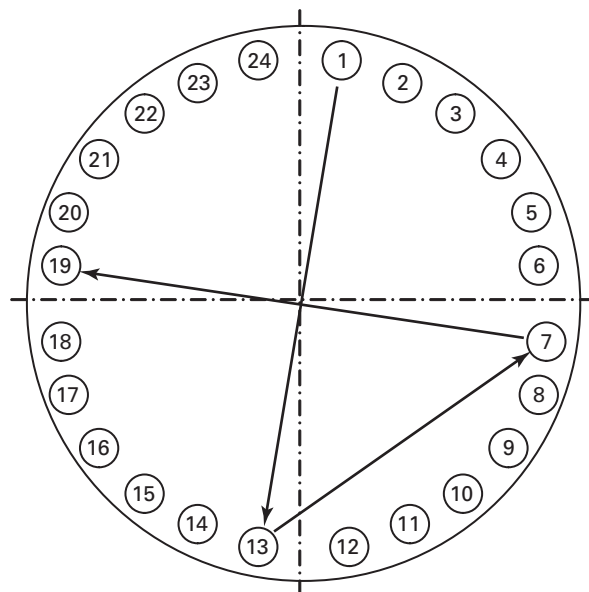

#### GENERAL NOTES:

(a) Pass 1a — 20% to 30% of Target Torque: 1,13,7,19

(b) Pass 1b — 50% to 70% of Target Torque: 1,13,7,19

(c) Pass 1c — 100% of Target Torque: 1,13,7,19

(d) Pass 1d onward — 100% of Target Torque, in circular pattern, until nuts do not turn. 1,2,3,4,5,6,7,8,9,10,11,12,13,14,15, 16,17,18,19,20,21,22,23,24 — 1,2,3, etc.

superior tightening parity, and parallel closure, in less time than using a single tool in a cross-pattern (see Fig. F-5). This method has been successfully applied in limited applications across the full range of gaskets and joint configurations commonly found in refining and petrochemical applications.

As a practical matter, multibolt tightening works best on larger flanges [bolt diameters M20 ( $\frac{3}{4}$  in.) or larger], with hydraulic tools connected to a common pressure source. One tool per every four to eight bolts in the flange should be used in even-numbered groups of tools equally distributed around the flange. For very critical and/or time sensitive bolting jobs, 50% or even 100% tool coverage is recommended.

NOTE: A minimum of four bolts are tightened simultaneously.

**F-1.4.1 Group Numbering.** Number the flange with the bolt sequence groups corresponding to the number of bolts in the flange and the number of tools employed (for this example, assume as shown in Fig. F-5, with four tools being used to tighten).

(a) Mark the bolts at the 12, 3, 6, and 9 o'clock positions with the number one.

(b) Moving clockwise, split the angles between the marked bolts and number the next group as number two.

(c) Split the remaining large angles as evenly as you can and continue numbering the groups until all bolts

<sup>2</sup> "Bolt Tightening Procedure for Pressure Boundary Flanged Joint Assembly," JSA JIS B 2251, 2008.

**Fig. F-5 Alternative Assembly Pattern #4  
(Multibolt Legacy Pattern)**

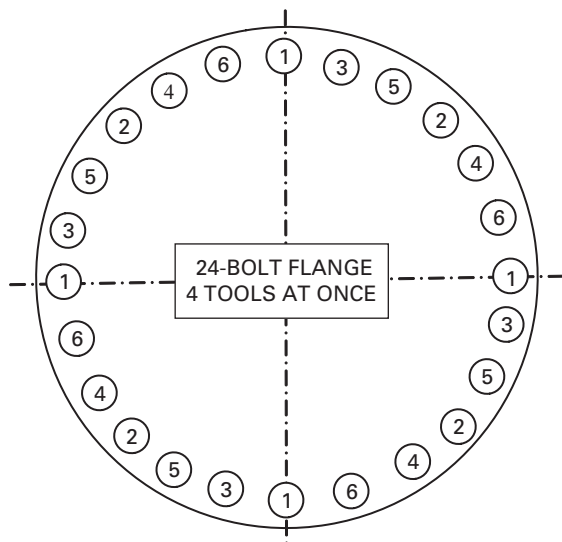

are numbered. All bolts are now numbered in groups at 90 deg from each of their own number.

**F-1.4.2 Tightening.** Tightening is accomplished in three Passes.

(a) Pass #1a and #1b: Tighten approximately one-fourth of the bolts to 50% of the Target Torque. In this example, tighten all of the 1s and then all of the 2s to 50% of the Target Torque. It is not necessary to do the remaining bolts because the purpose of this initial Pass is to seat the gasket and square up the flange. Flange alignment and gap should be checked. The remaining bolts will have loosened so time can be saved at this point by snugging them again.

(b) Pass #1c: Tighten all of the bolts to 100% of the Target Torque beginning with the 3s then 4s then 5s then 6s then returning to the 1s then 2s.

(c) Pass #2 (check Pass): Beginning from the end of the previous Pass at 100% of the Target Torque, move the tools clockwise one bolt at a time until the nuts no longer turn. This is the check Pass that compensates for elastic interaction and brings all bolts into parity.

This same procedure is used regardless of the number of tools. The only exception would be 100% coverage where tightening is done in one Pass. A modified Legacy pattern for Passes listed above is shown in Fig. F-10.

### F-1.5 Alternative Assembly Pattern #5

The following describes a simultaneous multibolt tightening pattern with a final circular pattern with two or more tools (refer to Fig. F-6).

(a) Pass #1a: Tighten bolts equally spaced 180 deg apart on opposite sides of the joint to 30% of Target Torque, then rotate tools 90 deg and simultaneously tighten these two bolts to 30% of Target Torque.

**Fig. F-6 Alternative Assembly Pattern #5  
(Multibolt Quadrant Pattern)**

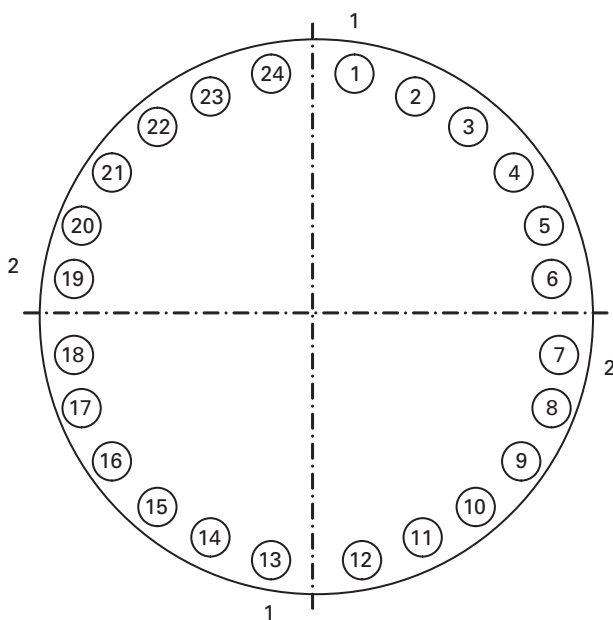

GENERAL NOTES: 24-Bolt Example:

- Pass 1a – Simultaneously, 30% of Target Torque: 1 & 13 then 7 & 19
- Pass 1b – Simultaneously, 60% of Target Torque: 1 & 13 then 7 & 19
- Pass 1c – Simultaneously, 100% of Target Torque: 1 & 13 then 7 & 19
- Pass 1d onward – Circular pattern, two tools @ 180 deg apart, 100% Target Torque until all nuts do not turn

(b) Pass #1b: Simultaneously tighten the first two bolts to 60% of Target Torque, then rotate tools 90 deg and simultaneously tighten these two bolts to 60% of Target Torque.

(c) Pass #1c: Simultaneously tighten the first two bolts to 100% of Target Torque, then rotate tools 90 deg and simultaneously tighten these two bolts to 100% of Target Torque.

(d) Pass #1d onward: Tighten all bolts, simultaneously in groups of two 180 deg apart, in circular Passes at 100% of Target Torque until the nuts no longer turn.

A step-by-step example of a modified Legacy pattern for Passes listed above is shown in Fig. F-11.

### F-1.6 Modified Pattern Summary

Table F-1 presents a summary of the procedures specified in this Appendix. Figures F-7 through F-11 show Alternative Assembly Patterns indicated in paras. F-1.1 through F-1.5, respectively.

## F-2 DEVELOPING NEW PROCEDURES

The procedures contained in section F-1 are not intended to be all-encompassing or to limit the development of application-specific alternative procedures. New

**Fig. F-7 Alternative Pattern #1: Modified Legacy Pattern (Single Tool)**

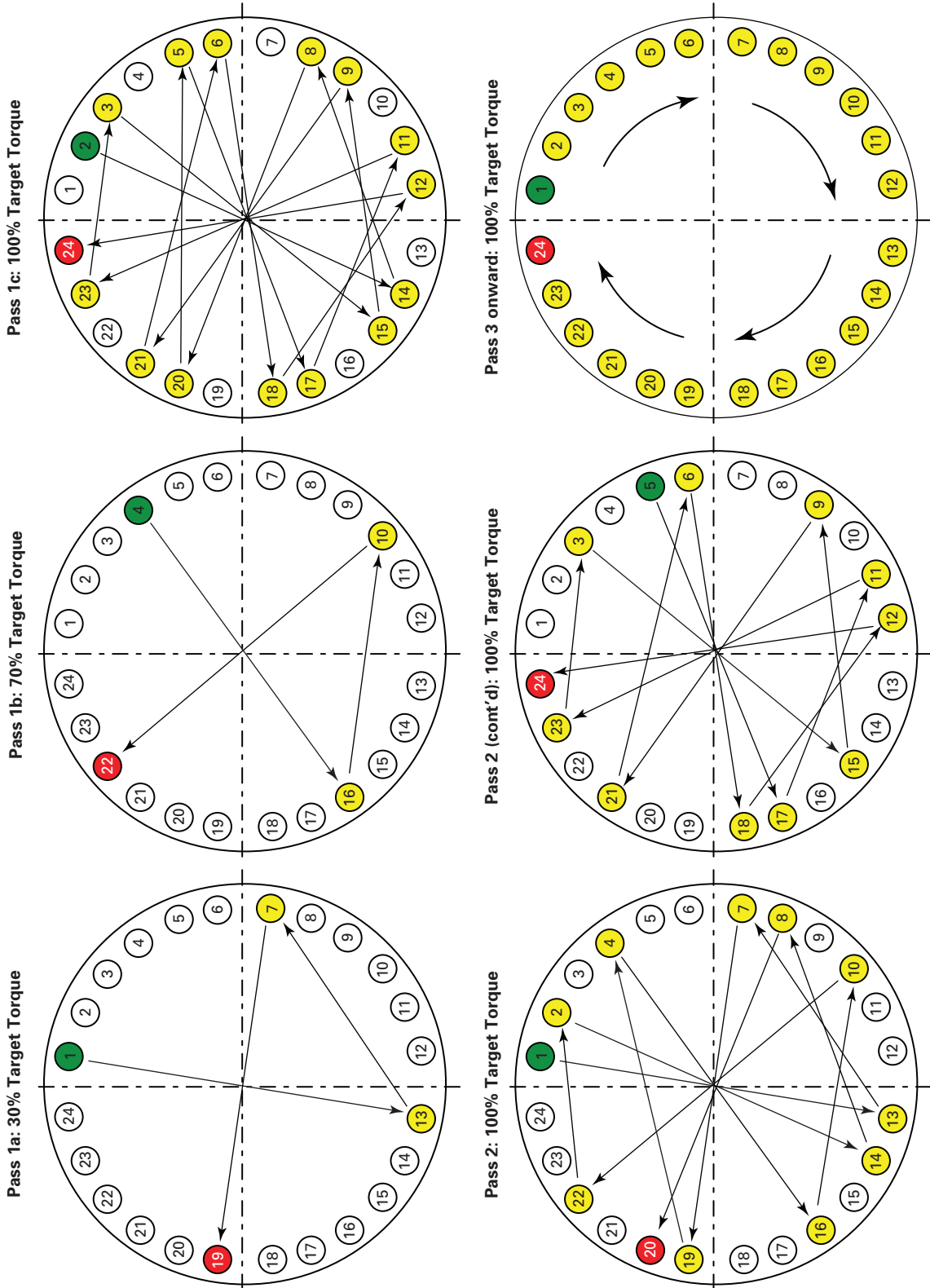

Fig. F-8 Alternative Pattern #2A: Quadrant Pattern: Star Sequencing (Single Tool)

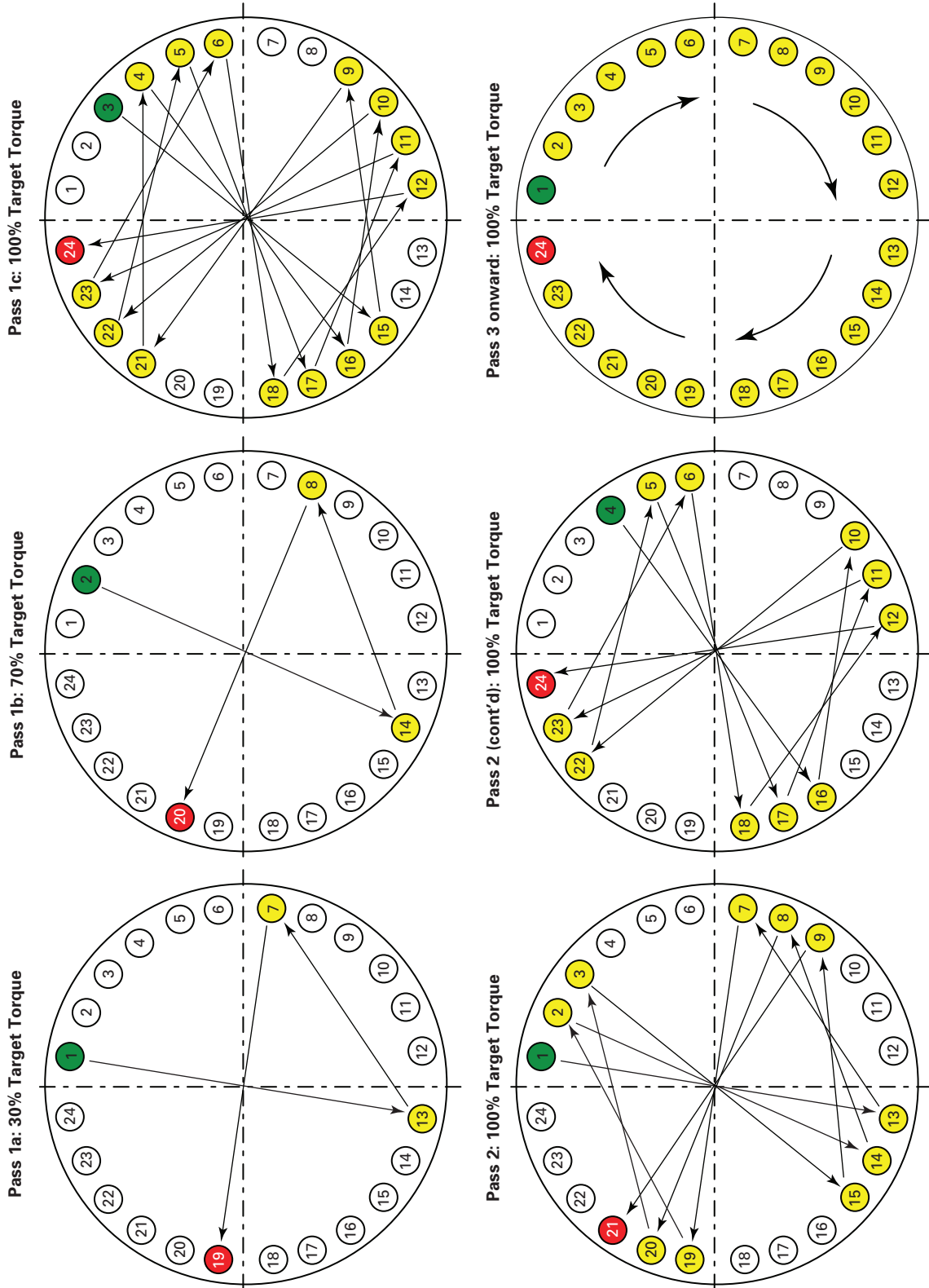
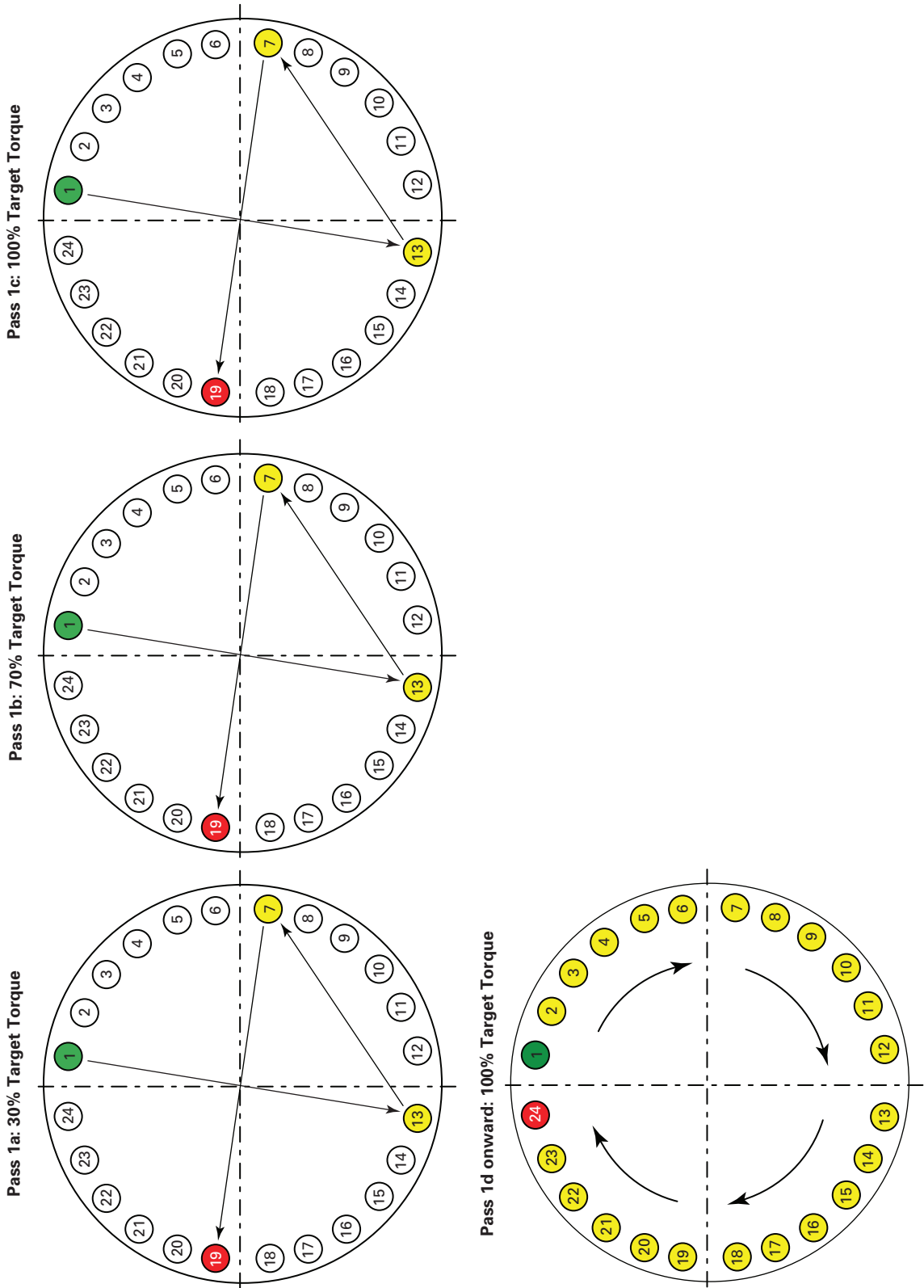
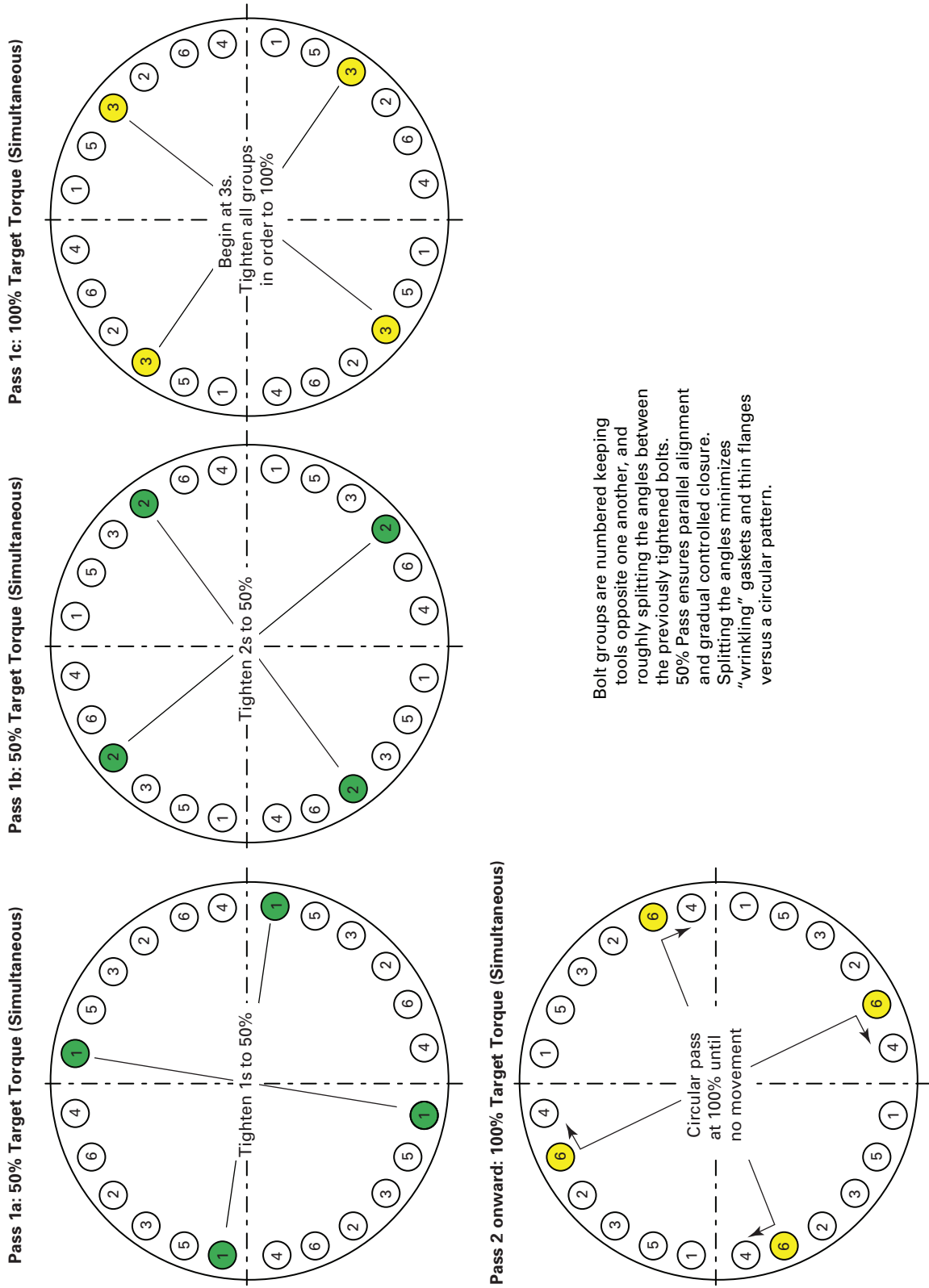

Fig. F-9 Alternative Pattern #3: Circular Pattern (Single Tool)

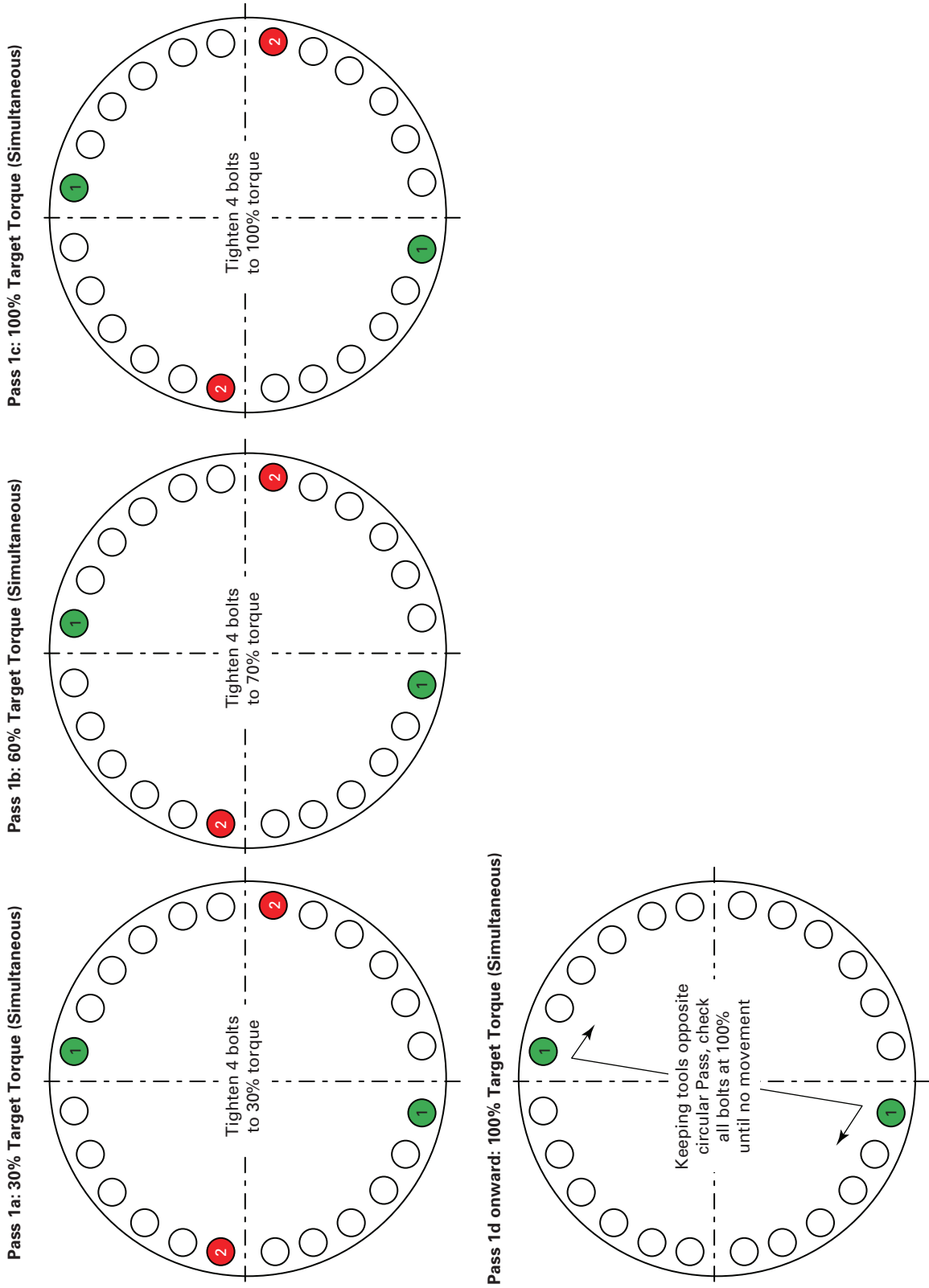

**Fig. F-10 Alternative Pattern #4: Simultaneous Multibolt Pattern (Four Tools)**



Bolt groups are numbered keeping tools opposite one another, and roughly splitting the angles between the previously tightened bolts. 50% Pass ensures parallel alignment and gradual controlled closure. Splitting the angles minimizes "wrinkling" gaskets and thin flanges versus a circular pattern.

**Fig. F-11 Alternative Pattern #5: Simultaneous Multibolt Pattern Example (Two Tools)**





alternative procedures may be developed that may be more effective and result in better sealing performance or less assembly effort for a given application. However, caution should be used in accepting new assembly procedures. There are, generally, two viable options for accepting bolted joint assembly procedures that are not listed in these guidelines.

(a) Option 1 is to use it and learn if it works by experience.

(b) Option 2 is to test a proposed procedure in an experimental setting and to measure certain parameters (such as uniformity of bolt preload, even gasket compression, physical damage to the gaskets, flanges and bolts, etc.) versus defined pass-fail criteria. Limitations of applying the experimental results to facility applications and comparison to existing procedures (section F-1) should be considered.

Option 1 is difficult to implement across industry because it requires people who closely monitor their bolting success rate and are able to differentiate between bolting procedure-induced failure versus other causes (incorrect flange design, incorrect bolt load specification, incorrect gasket selection, incorrect bolt assembly, etc.). Successful completion of a hydrostatic test is not considered sufficient evidence to confirm the acceptability of an assembly procedure. Bolting contractors may not have sufficient knowledge of the long term operating success of their procedure to be able to comment on the applicability of the procedure to a given application.

Implementing a new procedure to “see if it works” should be done with caution and may not be an option, as usually the consequences of failure will outweigh any advantage. Another possibility to implement this option is to use a bolting contractor’s experience or other facility’s experience to prove the method works (this often means relying on secondhand information). However, this process also requires the input of someone knowledgeable enough to determine if the experience in the other facilities will translate into your facility. The user is required to determine if his particular application is within the limits of the procedure.

There are many facilities that are successfully using alternative procedures developed over time and thereby are reducing their workload considerably, but over a limited range of gasket, flange types, and operating conditions. Their experience and the applicability of the procedure may or may not be transferable to other facilities/applications. Sound engineering practice and judgment should be used to determine the applicability of a specific procedure or part of a procedure to a given application.

### F-3 RTJ AND LENS-TYPE GASKETS

RTJ and lens-type gaskets have additional considerations that must be accounted for when determining the most appropriate assembly procedure. The axial movement of the flanges is significant for these gasket types. In addition, they are sensitive to flange misalignment either prior to or during joint assembly. Due to the large amount of axial movement of the flanges during assembly, the mechanical interaction (reduction of neighboring bolt load when a bolt is tightened) can be significant. Therefore, it is necessary to perform multiple pattern passes to ensure uniform joint closure, and multiple final circular passes to ensure that the desired target load is obtained. For large-diameter RTJ flanges (>NPS 12), this may mean performing four pattern passes and six or more circular passes, even when employing an alternative assembly procedure such as the one outlined in para. F-1.2 or F-1.3.

Significant advantage (reduction in the number of passes) is possible by using multiple tightening heads (two, four, or more) to simultaneously tighten bolts on the joint. This has the effect of bringing the joint together more uniformly and reduces the effect of mechanical interaction. In addition, it is recommended that the tightening procedure incorporate gap measurement (measurement of the gap between the outer diameter of the raised faces or flange; see para. 11.2) during joint assembly. The reduction in gap should be uniform during assembly, which indicates correct seating of the gasket.



## APPENDIX G

# USE OF CONTRACTORS SPECIALIZING IN BOLTING SERVICES

### G-1 HIRING OF CONTRACTORS

Contractors providing bolting services should preferably be hired directly by the user. If bolting contractors are not hired by the user, the user's approval of the subcontractor is required.

### G-2 CONTRACTOR'S AUTHORITY AND FUNCTIONS

Contractors providing bolting services should be given authority to execute and verify all aspects of the assembly process, with the understanding that the contractor should provide the user with a daily report containing sufficient detail, the review of which will allow the user to verify that the joint assembly activities have been performed as specified. In accordance with para. A-1.1.3, it is the responsibility of the contractor to ensure the competency of their employees for the task assigned. Contractors' functions may include, but are not limited to, the following:

(a) Prepare written joint assembly procedure(s) (or accept those provided by others) that comply with the essential elements of this Guideline.

(b) Review and verify that the competency of the assigned assemblers is suitable to the need.

(c) Coordinate with user's Inspector (or other user-designated agent) for approval of deviations from agreed-upon procedures.

(d) Provide tools needed for bolt-up procedures (e.g., hydraulic torquing and tensioning equipment).

(e) Provide and supervise personnel to perform final assembly of flanged joints.

(f) Monitor and advise user's maintenance personnel used during joint assembly, if any.

(g) Provide and supervise bolt elongation (stretch control) as specified.

(h) Provide user with report covering each joint assembled, including, as a minimum, the record information listed in section 14 of this Guideline.

## APPENDIX H

### BOLT ROOT AND TENSILE STRESS AREAS

**Table H-1 Bolt Root and Tensile Stress Areas**

SI Units			U.S. Customary Units			
Bolt Size, Basic Thread Designation [Notes (1), (2)]	Root Area, mm <sup>2</sup>	Tensile Stress Area, mm <sup>2</sup> [Note (3)]	Bolt Size, in.	Threads per Inch	Root Area, in. <sup>2</sup>	Tensile Stress Area, in. <sup>2</sup> [Note (3)]
M14-2	102.1	115.4	1/2	13	0.1257	0.1419
M16-2	141.0	156.7	5/8	11	0.2017	0.2260
M20-2.5	220.4	244.8	3/4	10	0.3019	0.3345
M24-3	317.3	352.5	7/8	9	0.4192	0.4617
M27-3	419.1	459.4	1	8	0.5509	0.6057
M30-3	535.0	580.4	1 1/8	8	0.7276	0.7905
M33-3	665.1	715.6	1 1/4	8	0.9289	0.9997
M36-3	809.3	864.9	1 3/8	8	1.155	1.234
M39-3	976.6	1 028	1 1/2	8	1.405	1.492
M42-3	1 140	1 206	1 5/8	8	1.680	1.775
M45-3	1 327	1 398	1 3/4	8	1.979	2.082
M48-3	1 527	1 604	1 7/8	8	2.303	2.414
M52-3	1 817	1 900	2	8	2.652	2.771
M56-3	2 132	2 222	2 1/4	8	3.422	3.557
M64-3	2 837	2 940	2 1/2	8	4.291	4.442
M70-3	3 432	3 545	2 3/4	8	5.258	5.425
M76-3	4 083	4 207	3	8	6.324	6.506
M82-3	4 791	4 925	3 1/4	8	7.487	7.686
M90-3	5 822	5 970	3 1/2	8	8.748	8.963
M95-3	6 518	6 674	3 3/4	8	10.11	10.34
M100-3	7 253	7 418	4	8	11.57	11.81

**NOTES:**

- (1) Metric thread designations are given in bolt size (mm) and pitch (mm) (e.g., M14-2 refers to a 14-mm-diameter bolt with a 2-mm-pitch thread).
- (2) The side-by-side placement of the two tables is not meant to infer direct conversion between the listed SI and U.S. Customary units.
- (3) The root and tensile stress areas are based on coarse-thread series for sizes M27 and smaller, and 3-mm-pitch thread series for sizes M30 and larger (coarse-thread series for sizes 1 in. and smaller, and 8-pitch thread series for sizes 1 1/8 in. and larger).

# APPENDIX I

## INTERACTION DURING TIGHTENING

### I-1 ELASTIC INTERACTION

Elastic interaction, sometimes called bolt cross-talk, can be explained as follows: As a joint is tightened, it compresses. Most of the compression occurs in the gasket, but additional compression also occurs in the flange. Local flange distortion under the bolt also is important. Subsequent tightening of individual bolts causes additional gasket compression and reduces the preload of previously tightened bolts.

### I-2 COUNTERING THE EFFECTS OF ELASTIC INTERACTION

The various joint assembly patterns covered in this document have been developed in order to apply load to the gasket reasonably uniformly during the tightening

process,<sup>1</sup> and to counter the effects of elastic interactions caused by the tightening process. The first bolts tightened in a given Pass receive the most interaction (preload reduction); the last bolts tightened receive none and the in-between bolts receive an intermediate amount of interaction. The purpose of the final Passes, during which the full Target Torque is applied in rotational order, is to reduce the remaining interaction effects to a practical minimum.

---

<sup>1</sup> If the bolts are tightened only in rotational order instead of as described herein, nonuniform compression of the gasket will occur and, as a result, the flanges are likely to become "cocked" (i.e., gap at outer perimeter of flanges will not be uniform), an indicator of nonuniform gasket loading and potential leakage. Additional tightening may not bring the flanges back parallel, and damage to the gasket can result.

## APPENDIX J

### CALCULATION OF TARGET TORQUE

Determining the appropriate torque value to apply to a given fastener set can be problematic. The difficulty is not in the formulas themselves but in accurately predicting the all-important friction coefficients upon which the calculations depend. Surface friction conditions can vary widely due to factors such as relatively loose manufacturing tolerances for standard threads, thread condition issues, new versus reused bolts and nuts, the presence of hardened washers versus turning on the flange face, variations in nut dimensions, and the presence of coatings and lubricants. Even if these friction conditions are experimentally determined with sufficient confidence, the fact remains that rigorous calculation of torque to a high degree of precision is generally unnecessary given the typically wide range of gasket sealing stresses available for most pressurized bolted joints. Consistency of applied torque and load within these broad ranges is usually much more important to the success of the joint than achieving a particular pin-point torque value.

The mathematical model relating the applied torque and tension in the bolt (preload) is generally given by

$$T = \frac{F}{2} \left[ \frac{p}{\pi} + \frac{\mu_t d_2}{\cos \beta} + D_e \mu_n \right]$$

This can be simplified for metric and Unified thread forms to

$$T = F \left[ 0.15915p + 0.57735\mu_t d_2 + \frac{D_e \mu_n}{2} \right]$$

or more approximately (from VDI 2230) to

$$T = F \left[ 0.16p + 0.58\mu_t d_2 + \frac{D_e \mu_n}{2} \right]$$

NOTE:

- $0.16p$  is the torque to stretch the bolt.
- $0.58\mu_t d_2$  is the torque to overcome thread friction.
- $\frac{D_e \mu_n}{2}$  is the torque to overcome face friction.

where

$D_e$  = effective bearing diameter of the nut face, mm (in.)

$$= (d_o + d_i)/2$$

$d_2$  = basic pitch diameter of the thread, mm (in.)  
(For metric threads,  $d_2 = d - 0.6495p$ ; for inch threads,  $d_2 = d - 0.6495/n$ .)

$d_i$  = inner bearing diameter of the nut face, mm (in.)

$d_o$  = outer bearing diameter of the nut face, mm (in.)

$F$  = bolt preload, N (lb)

$n$  = number of threads per inch, in.<sup>-1</sup> (applies to inch threads)

$p$  = pitch of the thread, mm (For inch threads, this is normally quoted as threads per inch,  $n$ ; i.e.,  $p = 1/n$ .)

$T$  = total tightening torque, N·mm (in.-lb)

$\beta$  = half included angle for the threads, deg (i.e., 30 deg for metric and Unified threads)

$\mu_n$  = coefficient of friction for the nut face or bolt head

$\mu_t$  = coefficient of friction for the threads

The preload  $F$  can be determined from

$$F = A_s \sigma_y P_{\%}$$

where

$A_s$  = tensile stress area of the thread, mm<sup>2</sup> (in.<sup>2</sup>) (see Appendix H)

$P_{\%}$  = percentage utilization factor for material yield strength (default value typically 50%; i.e.,  $P_{\%} = 0.5$ )

$\sigma_y$  = minimum yield strength of the bolt material, N/mm<sup>2</sup> (lb/in.<sup>2</sup>)

Additional information on torque formulas and the effect of friction factors may be found in the *Handbook of Bolts and Bolted Joints*.<sup>1</sup> Chapter 3 provides detailed formulas. Chapters 12 and 32 provide substantial additional theoretical and experimental information and equations, including the more specific formula that is shown above. This formula applies to standard 60-deg thread angle ASME fasteners and has the advantage of discretely reflecting the three specific resistance components as provided above. The same discrete approach is also used in EN 1591-1, ISO 27509, and VDI 2230.

A simplified formula for calculating Target Torque is presented in Appendix K. Long experience has shown the “nut factor” method to be equally effective as the more complex formulas. While the nut factor method does not address all of the variables that can affect the torque–preload relationship, it produces similar and fully acceptable values for the assembly of flanges under this Guideline.

<sup>1</sup> Bickford, John H., and Nassar, Sayed, eds., 1998. “Handbook of Bolts and Bolted Joints,” New York, Marcel Dekker, Inc.

## APPENDIX K

### NUT FACTOR CALCULATION OF TARGET TORQUE

A common method for calculating Target Torque is the use of the following formula:

(SI Units)

$$T = K D F / 1000 \quad (\text{K-1M})$$

(U.S. Customary Units)

$$T = K D F / 12 \quad (\text{K-1})$$

where

- $D$  = nominal diameter of the bolt, mm (in.)
- $F$  = target bolt load, N (lb)
- $K$  = nut factor (see below)
- $T$  = Target Torque, N·m (ft·lb)

“ $K$ ” is an experimentally determined dimensionless constant related to the coefficient of friction. The value of  $K$  in most applications at ambient temperature is generally considered to be approximately equal to the coefficient of friction plus 0.04.<sup>1</sup> Based on the above, friction coefficients of 0.16 and 0.12 (see Table 1M/ Table 1 of this Guideline) correspond approximately to nut factors of 0.20 and 0.16 for noncoated and coated bolts, respectively.

Published tables of experimental nut factors are available from a number of sources; however, care must be taken to ensure that the factors are applicable to the application being considered. Typical nut factors for industrial pressure vessel and piping applications using

<sup>1</sup> “An Introduction to the Design and Behavior of Bolted Joints,” Bickford, p. 233.

SA-193 low-alloy steel bolts range from 0.16 to 0.23 at ambient temperature. It is worthwhile to note the sensitivity of obtained load to an applied torque from relatively small changes in nut factor. For example, a change from 0.1 to 0.3 does not result in a 20% change in torque, but a 200% change. Insufficient application of lubricant to the working surfaces will have the effect of adding significant variability to the obtained bolt load.

It should also be noted that recent research has shown there to be nut factor dependence on bolt material, bolt diameter, and assembly temperature. These factors can be significant<sup>2</sup> and should not be ignored when selecting the nut factor or antiseize compound. The user is advised either to seek test results conducted on similar bolt and antiseize specifications or to conduct nut factor trials (size and material) with their own conditions. Nut factor trials can be conducted relatively easily by tightening a bolt using torque and measuring the obtained bolt load by calibrated ultrasonic measurement, use of a calibrated load cell, or measuring pressure rise on a hydraulic tensioner. In addition, the maximum temperature listed by the manufacturer for a given antiseize product has not been found to be a reliable indicator that the product will improve disassembly of the joint after operation at elevated temperature. Once again, it is recommended that test results on similar materials and operating conditions be sought to guide the user on the appropriate product to be employed in a given service.

<sup>2</sup> In test results the effect of temperature was found to halve the nut factor over the ambient temperature range often found in the field [0°C to 40°C (32°F to 100°F)] for one antiseize product. In addition, the nut factor has been found to increase by 30% with SA-193 B8M bolts, by comparison to SA-193 B7 bolt material tests.

## APPENDIX L

### ASME B16.5 FLANGE BOLTING INFORMATION

Table L-1 ASME B16.5 Flange Bolting Information

Flange Size (NPS)	Class 150		Class 300		Class 400		Class 600		Class 900		Class 1500		Class 2500	
	#	Size	#	Size	#	Size	#	Size	#	Size	#	Size	#	Size
1/2	4	1/2	4	1/2	4	1/2	4	1/2	4	3/4	4	3/4	4	3/4
3/4	4	1/2	4	5/8	4	5/8	4	5/8	4	3/4	4	3/4	4	3/4
1	4	1/2	4	5/8	4	5/8	4	5/8	4	7/8	4	7/8	4	7/8
1 1/4	4	1/2	4	5/8	4	5/8	4	5/8	4	7/8	4	7/8	4	1
1 1/2	4	1/2	4	3/4	4	3/4	4	3/4	4	1	4	1	4	1 1/8
2	4	5/8	8	5/8	8	5/8	8	5/8	8	7/8	8	7/8	8	1
2 1/2	4	5/8	8	3/4	8	3/4	8	3/4	8	1	8	1	8	1 1/8
3	4	5/8	8	3/4	8	3/4	8	3/4	8	7/8	8	1 1/8	8	1 1/4
3 1/2	8	5/8	8	3/4	8	7/8	8	7/8	...	...	...	...	...	...
4	8	5/8	8	3/4	8	7/8	8	7/8	8	1 1/8	8	1 1/4	8	1 1/2
5	8	3/4	8	3/4	8	7/8	8	1	8	1 1/4	8	1 1/2	8	1 3/4
6	8	3/4	12	3/4	12	7/8	12	1	12	1 1/8	12	1 3/8	8	2
8	8	3/4	12	7/8	12	1	12	1 1/8	12	1 3/8	12	1 5/8	12	2
10	12	7/8	16	1	16	1 1/8	16	1 1/4	16	1 3/8	12	1 7/8	12	2 1/2
12	12	7/8	16	1 1/8	16	1 1/4	20	1 1/4	20	1 3/8	16	2	12	2 3/4
14	12	1	20	1 1/8	20	1 1/4	20	1 3/8	20	1 1/2	16	2 1/4	...	...
16	16	1	20	1 1/4	20	1 3/8	20	1 1/2	20	1 5/8	16	2 1/2	...	...
18	16	1 1/8	24	1 1/4	24	1 3/8	20	1 5/8	20	1 7/8	16	2 3/4	...	...
20	20	1 1/8	24	1 1/4	24	1 1/2	24	1 5/8	20	2	16	3	...	...
24	20	1 1/4	24	1 1/2	24	1 3/4	24	1 7/8	20	2 1/2	16	3 1/2	...	...

# APPENDIX M

## WASHER USAGE GUIDANCE AND PURCHASE SPECIFICATION FOR THROUGH-HARDENED WASHERS

### M-1 WASHER USAGE GUIDANCE

#### M-1.1 Usage

The use of washers on pressure boundary bolted flange joints is optional. However, it is generally recognized that the use of through-hardened steel washers will improve the translation of torque input into bolt preload by providing a smooth and low friction bearing surface for the nut.

Washers protect the contact surface of the flange from damage caused by a turning nut. These are important considerations when torquing methods (either manual or hydraulic) are used for bolt tightening.

This Appendix specifies the procurement of through-hardened washers for bolted flange joints covered within the scope of this Guideline. The use of surface-hardened washers is not recommended since the soft interior material under direct compression will flow plastically, causing washer cupping and thinning with associated reduction in preload.

#### M-1.2 Dimensions

The outside diameter of the washers detailed in this Appendix was selected to enable their use on flanges with spot faces or back facing meeting the requirements of standard ISO 7005-1 (Piping flanges — Part 1: Steel flanges for industrial and general service piping systems) for metric flanges and MSS SP-9 (Spot Facing for Bronze, Iron and Steel Flanges) for inch flanges.

The inside diameter of these washers was selected to enable their use under the nut. Use of these washers under the head of a bolt may lead to interference with the bolt shank or underhead fillet.

#### M-1.3 Service Temperature (Washer Temperature)

Service temperature limits are shown in Table M-1.

Note that in operation, actual bolting temperature may be lower than process fluid temperature.

For uninsulated joints, ASME B31.3 (Process Piping) considers flange bolting temperature to be 80% of fluid temperature.

#### M-1.4 Existing Standards

Washers in accordance with ASTM F436 have been used previously on piping flanges. However, the use of ASTM F436 washers may lead to interference with the

**Table M-1 Service Temperature Limits**

Material Type	Single-Use [Note (1)]	Reuse [Note (2)]
1	425°C (800°F)	205°C (400°F)
4	540°C (1,000°F)	400°C (750°F)
5	650°C (1,200°F)	425°C (800°F)
6	815°C (1,500°F)	550°C (1,025°F)

#### NOTES:

- (1) Single-use service temperature limits are based on replacement whenever the existing washer has been exposed to temperature in excess of the corresponding reuse limit.
- (2) Reuse service temperature limits are based on metallurgical concerns (softening) for the washer material.

spotface/backfacing on the flanges. Also, ASTM F436 does not provide dimensions for certain nominal sizes needed for pipe or vessel flanges. The intent of the Type 1 washer in this Appendix is to specify a washer of the same general material as an ASTM F436 washer but with revised dimensions to make them compatible with pipe or vessel flanges.

#### M-1.5 Previous Material

Figures 1 and 2 in the original edition of ASME PCC-1 referenced ASME SA-540 for the manufacture of washers for elevated temperature. This Appendix does not continue the use of this material due to material cost and manufacturing concerns. Discontinuation of the use of SA-540 material does not imply that this material is technically deficient.

#### M-1.6 Material Application

Types 1 and 4 washer materials are intended for use with steel fasteners such as Grade 2H, 4, or 7 steel nuts per ASME SA-194. The Type 4 washer material is an alloy steel with higher service temperature. Types 5 and 6 washer materials are intended for use with austenitic steel fasteners such as Grade 8 austenitic steel nuts per ASME SA-194. The Type 6 washer material is a precipitation hardening stainless steel that has increased corrosion resistance as compared to Type 5 washer material.

#### M-1.7 Installation

To avoid any concerns about the effect of washer markings on the performance of the washer to nut interface,

it is recommended that these washers be installed with the marked face towards the flange surface.

## M-2 PURCHASE SPECIFICATION FOR THROUGH-HARDENED WASHERS

### M-2.1 Scope

**M-2.1.1** This Appendix covers the chemical, mechanical, and dimensional requirements for through-hardened steel washers for use with fasteners having nominal sizes of 14 mm to 100 mm and ½ in. to 4 in. These washers are intended for use on pressure containing flanges with bolts or studs and nuts. These washers are suitable for use with low alloy steel and austenitic steel fasteners covered in ASME SA-193 and SA-194.

**M-2.1.2** The types of washers covered are

- (a) Type 1 — Carbon steel
- (b) Type 4 — Low alloy steel
- (c) Type 5 — Martensitic steel
- (d) Type 6 — Precipitation hardening steel

### M-2.2 Ordering Information

Orders for washers under this specification shall include the following:

- (a) nominal size
- (b) type (see para. M-2.1.2)
- (c) quantity (number of pieces)

### M-2.3 Materials and Manufacture

**M-2.3.1** Steel used in the manufacture of washers shall be produced by the open-hearth, basic-oxygen, or electric-furnace process.

**M-2.3.2** Washers up to and including 100 mm (4 in.) nominal size shall be through-hardened.

**M-2.3.3** Minimum tempering (precipitation) temperatures shall be as follows:

- (a) For Type 1, 205°C (400°F)
- (b) For Type 4, 370°C (700°F)
- (c) For Type 5, 425°C (800°F)
- (d) For Type 6, 550°C (1,025°F)

### M-2.4 Chemical Composition

Washers shall conform to the chemical composition specified in Table M-2.

### M-2.5 Mechanical Properties

Washers shall have a hardness of 38 HRC to 45 HRC except Type 6 washers shall have a hardness of 33 HRC to 42 HRC.

### M-2.6 Dimensions and Tolerances

**M-2.6.1** Washers shall conform to the dimensions shown in Table M-3 or M-4 with tolerances shown in Table M-5 or M-6 as applicable.

**M-2.6.2** Washers shall have a multidirectional lay with a surface roughness not exceeding 3.2 μm (125 μin.) in height including any flaws in or on the surface. Surface roughness shall be as defined in ASME B46.1.

### M-2.7 Workmanship, Finish, and Appearance

Washers shall be free of excess mill scale, excess coatings, and foreign material on bearing surfaces. Arc and gas cut washers shall be free of metal spatter.

### M-2.8 Sampling and Number of Tests

**M-2.8.1** A lot of washers shall consist of all material offered for inspection at one time that has the following common characteristics:

- (a) same nominal size
- (b) same material grade
- (c) same heat treatment

**M-2.8.2** From each lot described in para. M-2.8.1, the number of specimens tested for each required property shall be as specified in Table M-7.

### M-2.9 Test Methods: Hardness

**M-2.9.1** A minimum of two readings shall be taken 180 deg apart on at least one face at a minimum depth of 0.38 mm (0.015 in.).

**M-2.9.2** Hardness tests shall be performed in accordance with the Rockwell test method specified in ASTM F606 or ASTM F606M.

### M-2.10 Product Marking

**M-2.10.1** Washers shall be marked with a symbol, or other distinguishing marks, to identify the manufacturer or private label distributor, as appropriate.

**M-2.10.2** Washers shall be marked with the type, "1," "4," "5," or "6," as applicable.

**M-2.10.3** All marking shall be depressed and located on the same face of the washer.

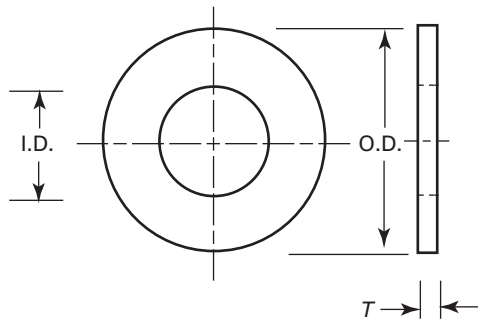

**Table M-2 Chemical Requirements**

Element	Composition, % [Note (1)]			
	Type 1	Type 4 [Note (2)]	Type 5 [Note (3)]	Type 6 [Note (4)]
Phosphorus (max.)	0.050	0.040	0.040	0.040
Sulfur (max.)	0.060	0.050	0.030	0.030

## NOTES:

- (1) Maximum.
- (2) Type 4 low-alloy steel washers shall be manufactured from SAE number 4130 or 4140 steel listed in ASTM A829.
- (3) Type 5 martensitic steel washers shall be manufactured from UNS S41000 steel listed in ASME SA-240.
- (4) Type 6 precipitation hardening steel washers shall be manufactured from UNS S17400 steel listed in ASME SA-693.

**Table M-3 Dimensional Requirements for Metric Washers**

Nominal Size, mm	Outside Diameter, O.D., mm	Inside Diameter, I.D., mm	Thickness, T, mm
14	28	15	3
16	30	17	4
20	37	21	5
24	44	25	6
27	50	28	6
30	56	31	6
33	60	34	6
36	66	37	6
39	72	42	6
42	78	45	6
45	85	48	6
48	92	52	6
52	98	56	6
56	105	62	6
64	115	70	6
70	125	76	6
76	135	82	6
82	145	88	6
90	160	96	6
95	165	101	6
100	175	107	6

GENERAL NOTE: Tolerances are as noted in Table M-5.

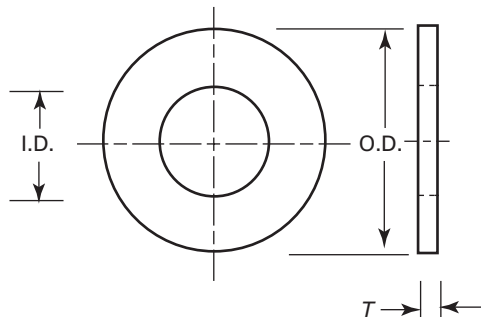
**Table M-4 Dimensional Requirements for U.S. Customary Washers**

Nominal Size, in.	Outside Diameter, O.D.		Inside Diameter, I.D.		Thickness, <i>T</i>	
	mm	in.	mm	in.	mm	in.
1/2	27.0	1.063	14.3	0.563	3.2	0.125
5/8	33.4	1.313	17.5	0.688	4.0	0.156
3/4	38.1	1.500	20.7	0.813	4.8	0.188
7/8	43.6	1.718	23.8	0.938	5.6	0.219
1	50.0	1.968	27.0	1.063	6.4	0.250
1 1/8	54.8	2.156	30.2	1.188	6.4	0.250
1 1/4	60.3	2.375	33.4	1.313	6.4	0.250
1 3/8	65.9	2.593	36.5	1.438	6.4	0.250
1 1/2	71.4	2.812	39.7	1.563	6.4	0.250
1 5/8	77.8	3.062	42.9	1.688	6.4	0.250
1 3/4	82.6	3.250	46.1	1.813	6.4	0.250
1 7/8	87.3	3.438	49.2	1.938	6.4	0.250
2	93.7	3.688	54.0	2.125	6.4	0.250
2 1/4	104.8	4.125	60.3	2.375	6.4	0.250
2 1/2	115.9	4.563	66.7	2.625	6.4	0.250
2 3/4	127	5.000	73.0	2.875	6.4	0.250
3	138.1	5.438	79.4	3.125	6.4	0.250
3 1/4	149.2	5.875	85.7	3.375	6.4	0.250
3 1/2	160.4	6.313	92.1	3.625	6.4	0.250
3 3/4	173.1	6.813	98.4	3.875	6.4	0.250
4	182.6	7.188	104.8	4.125	6.4	0.250

GENERAL NOTE: Tolerances are as noted in Table M-6.

**Table M-5 Dimensional Tolerances for Metric Washers**

Dimensional Characteristics	14–16 mm	20–27 mm	30–42 mm	45–76 mm	82–100 mm
	Nominal Size	Nominal Size	Nominal Size	Nominal Size	Nominal Size
Inside diameter, I.D., mm	–0, +0.4	–0, +0.5	–0, +0.6	–0, +0.7	–0, +0.9
Outside diameter, O.D., mm	–1.3, +0	–1.6, +0	–1.9, +0	–2.2, +0	–2.5, +0
Thickness, <i>T</i> , mm	±0.15	±0.15	±0.15	±0.15	±0.15
Flatness, mm (max. deviation from straightedge placed on cut side)	0.25	0.30	0.40	0.50	0.80
Concentricity, FIM [Note (1)], mm (inside to outside diameters)	0.3	0.5	0.5	0.5	0.5
Burr height, mm (max. projection above adjacent washer surface)	0.25	0.40	0.40	0.50	0.65

NOTE:

(1) Full indicator movement.

**Table M-6 Dimensional Tolerances for U.S. Customary Washers**

Dimensional Characteristics	< 1 in.		1 through 1½ in.		> 1½ through 3 in.		> 3 in.	
	Nominal Size		Nominal Size		Nominal Size		Nominal Size	
	mm	in.	mm	in.	mm	in.	mm	in.
Inside diameter, I.D.	–0	–0	–0	–0	–0	–0	–0	–0
	+0.81	+0.032	+0.81	+0.032	+1.60	+0.063	+1.60	+0.063
Outside diameter, O.D.	±0.81	±0.032	±0.81	±0.032	±1.60	±0.063	±1.60	±0.063
Thickness, <i>T</i>	±0.13	±0.005	±0.13	±0.005	±0.13	±0.005	±0.13	±0.005
Flatness (max. deviation from straightedge placed on cut side)	0.25	0.010	0.38	0.015	0.51	0.020	0.81	0.032
Concentricity, FIM [Note (1)] (inside to outside diameters)	0.81	0.032	0.81	0.032	1.60	0.063	1.60	0.063
Burr height (max. projection above adjacent washer surface)	0.25	0.010	0.38	0.015	0.51	0.020	0.64	0.025

NOTE:

(1) Full indicator movement.

**Table M-7 Sampling**

Number of Pieces in Lot	Number of Specimens
800 and under	1
801 to 8,000	2
8,001 to 22,000	3
Over 22,000	5

# APPENDIX N

## DEFINITIONS, COMMENTARY, AND GUIDELINES ON THE REUSE OF BOLTS

### N-1 TERMS AND DEFINITIONS

*abused*: any form of explicit or implicit treatment that damages the integrity of the fastener, such as uncontrolled tightening, overtightening, tightening without sufficient lubrication, or process operational extremes.

*bolt with integral head*: threaded fastener with a fixed/forged head on one end and employing a nut or a drilled and tapped hole on the other end.

*bolt without integral head*: fully threaded fastener employing two nuts or one nut and a drilled and tapped hole.

*common grades*: materials common to the facility/industry in satisfactory quantity and price as to be considered the normal material to use. For example, the refining industry common grades of threaded fasteners would be SA-193 B7 bolts and SA-194 2H nuts or SA-193 B16 bolts and SA-194 4 or 7 nuts.

*controlled reuse*: the first and subsequent uses thereafter have been conducted and documented under specific thread engagement, locations, torque, tension, lubrication, inspection, nut replacement, handling, cleaning, and installation guidelines.

*critical issues*: any issue that directly contributes to or results from the proper or improper assembly of a joint. Critical issues increase with the criticality of the joint and therefore the fastener cost factor usually remains.

*retighten*: tightening again as in a subsequent assembly. This does not include tightening the fastener again as in to turn the nut to a tighter position from a static position.

*reuse*: to use more than once.

*tighten*: apply load to the threaded fastener system through some means of turning of the nut or direct tension.

*uncontrolled reuse*: the first and any subsequent uses thereafter have been conducted without documentation.

*use*: the process whereby a threaded fastener or group of such fasteners is installed in a joint and tightened for the purpose of obtaining and maintaining a seal between the flanges.

### N-2 GENERAL COMMENTARY

The following discussions are limited to site and field application:

(a) Successful flange joint assembly is subject to a large number of variables both in joint design and field conditions. The fastener system materials, quality, and condition have a large influence over the total outcome.

(b) While it is recognized that even new fasteners may produce  $\pm 30\%$  variation in bolt load when torqued, it is also recognized that when properly installed and well lubricated, the majority of the fasteners will produce loads in the  $\pm 15\%$  variation range with many falling into the  $\pm 10\%$  variation range. This is why torque is successful for many applications. Keeping as many fasteners in the 10% to 15% variation range is very important.

(c) When the threads of new fasteners engage under load, they wear on each other. The surfaces and friction change and therefore their performance is forever changed. Dry or poorly lubricated fasteners tend to create higher friction conditions, while well lubricated fasteners tend to create lower friction conditions. Each subsequent engagement of the same threads will produce similar results until an optimum or minimum condition occurs. Depending on the fastener size, the load change may vary from a few hundred pounds to a few thousand pounds.

(d) The axial compression of a nut, and the extension of the bolt within the nut, have to be reconciled by means of other types of deformation, since thread contact requires the same deformation of nut and bolt along the bearing surfaces of the two thread systems. The reconciling influences of this incompatible simple axial strain have been identified to be

(1) thread bending (threads act as cantilevers)

(2) thread recession (lateral expansion of the nut accompanying the compressive axial stress, plus lateral expansion due to radial component of thread load)

(3) nut wall bending (nut becomes slightly conically shaped due to higher radial loadings at first engaged threads, thereby shifting some load to the adjacent threads)

The bottom-line result of this load transfer from bolt to nut is that the first threads of engagement are subjected to a high unit loading since a major part of the load tends to transfer through these first threads.

(e) From the previous points it can be seen that working and reworking the same threads in a proper installation can be beneficial.

(1) In the case of bolts with an integral head, it is very simple to rework the same threads over and over from assembly to assembly by simply properly installing the same nut on the same bolt each time. Since the flange determines the grip length (effective stretching length), the same threads are always being worked.

(2) In the case of bolts without integral head, it is virtually impossible to work and rework the same threads given the current workforce practices. When it becomes necessary to reuse bolts without integral heads, strict control is advised to ensure that the threaded fasteners are correctly installed with some means of determining that you are working the same threads. A complete change of the nuts is also a step that may create more uniformity.

(f) When using torque devices without a measurement of load or elongation, determination of the friction condition of a fastener is difficult. However, creating similar and fairly predictable conditions on a group of fasteners is more practical. Starting with new threaded fasteners and treating them all the same is an effective and common way to minimize load variability from bolt to bolt.

(g) Continuous reuse is an option when you have adequately attended to the issues herein discussed.

(h) If an adequate bolt reuse system is used, it is advised that the fasteners be periodically replaced based on the following:

(1) operational fatigue or abuse, surface and/or integral inspections, mechanical integrity inspections, galling, nut not running freely, difficult disassembly, or joint leakage.

(2) if one bolt in a joint is replaced, it is recommended that all be replaced. If all bolts cannot be changed, and more than one bolt is changed, space them symmetrically around the bolt circle so that they are surrounded by old fasteners.

(i) Tightening methods that do not apply friction loads to the threads during the loading process, such as hydraulic or mechanical tensioning, usually do not have a detrimental effect on the threads due to the lack of friction during the loading.

(j) While factors such as handling, transporting, and storage are very important, suffice it to say that those shall be done in a manner as to preserve both the quality and integrity of the fastener and fastener threads.

(k) Working with and reconditioning fasteners in the field is expensive and unpredictable when compared to cost of new. Reconditioning/replacement considerations could include

(1) number of bolts to recondition

(2) availability of new bolts

(3) labor cost

(4) criticality of the BFJ

(5) previously applied coating such as polyimide/amide [see Notes (2) and (3) of Table 1M/Table 1]

### N-3 GUIDELINES

(a) When using bolts and nuts of common grade for fasteners up to M30 (1 $\frac{1}{8}$  in.) diameter, the use of new bolts and nuts is recommended when bolt-load control methods such as torque or tension are deemed necessary. For larger diameters, it is recommended that the cost of cleaning, deburring, and reconditioning be compared to the replacement cost and considered in the assessment of critical issues of the assembly.

(b) Strong consideration should be given to replacing bolts of any size should it be found that they have been abused or nonlubricated during previous assemblies.

(c) Thread dies generally do not yield a highly cleaned reconditioned surface; therefore, turning bolt threads in a lathe is the preferred method to recondition costly fasteners. Although preferred, this process will remove thread material and tolerance limits specified in ASME B1.1 must be maintained.

(d) Nuts are not generally reconditioned.

## APPENDIX O

### ASSEMBLY BOLT STRESS DETERMINATION

#### O-1 INTRODUCTION

##### O-1.1 Scope

The intent of this Appendix is to provide guidance for the determination of an appropriate assembly bolt stress with due consideration for joint integrity. The detailed procedures provided in this Appendix are intended for flange joints for which controlled assembly methods are to be used. Provisions are made for both a simple approach and for a joint component approach.

##### O-1.2 Cautions

The provisions of this Appendix consider that the ASME PCC-1 guidelines for the joint component condition (flange surface finish, bolt spacing, flange rigidity, bolt condition, etc.) are within acceptable limits.

The methodology outlined below assumes that the gaskets being used undergo a reasonable amount (>15%) of relaxation during the initial stages of operation, such that the effects of operational loads in increasing the bolt stress need not be considered (i.e., gasket relaxation will exceed any operational bolt-load increase). In some rare cases, this may not be the case, and the limits should then also be checked at both the ambient and operating bolt stress and temperatures. For most standard applications, this will not be necessary.

In addition, the methodology is for ductile materials (strain at tensile failure in excess of 15%). For brittle materials, the margin between the specified assembly bolt stress and the point of component failure may be considerably reduced and, therefore, additional safety factors should be introduced to guard against such failure.

The method does not consider the effect of fatigue, creep, or environmental damage mechanisms on either the bolt or flange. These additional modes of failure may also need to be considered for applications where they are found and additional reductions in assembly bolt stress may be required to avoid joint component failure.

##### O-1.3 Definitions

$$A_b = \text{bolt root area, mm}^2 \text{ (in.}^2\text{)}$$

$$A_g = \text{gasket area } [\pi/4 (G_{O.D.}^2 - G_{I.D.}^2)], \text{ mm}^2 \text{ (in.}^2\text{)}^1$$

<sup>1</sup> Where a gasket has additional gasket area, such as a pass partition gasket, which may not be as compressed as the main outer sealing element, due to flange rotation, then a reduced portion of that area, such as half the additional area, should be added to  $A_g$ .

$G_{I.D.}, G_{O.D.}$  = gasket sealing element inner/outer diameter, mm (in.)

$K$  = nut factor (for bolt material and temperature)

$n_b$  = number of bolts

$P_{max}$  = maximum design pressure, MPa (psi)

$S_{ya}$  = flange yield stress at assembly, MPa (psi)

$S_{yo}$  = flange yield stress at operation, MPa (psi)

$Sb_{max}$  = maximum permissible bolt stress, MPa (psi)

$Sb_{min}$  = minimum permissible bolt stress, MPa (psi)

$Sb_{sel}$  = selected assembly bolt stress, MPa (psi)

$Sf_{max}$  = maximum permissible bolt stress prior to flange damage, MPa (psi)

$Sg_T$  = target assembly gasket stress, MPa (psi)

$Sg_{max}$  = maximum permissible gasket stress, MPa (psi)

$Sg_{min-O}$  = minimum gasket operating stress, MPa (psi)

$Sg_{min-S}$  = minimum gasket seating stress, MPa (psi)

$T_b$  = assembly bolt torque, N·m (ft·lb)

$\phi_b$  = bolt diameter, mm (in.)

$\theta_{f_{max}}$  = single flange rotation at  $Sf_{max}$ , deg

$\theta_{g_{max}}$  = maximum permissible single flange rotation for gasket at the maximum operating temperature, deg

$\varphi_g$  = fraction of gasket load remaining after relaxation

#### O-2 ASSEMBLY BOLT STRESS SELECTION

It is recommended that bolt assembly stresses be established with due consideration of the following joint integrity issues:

(a) *Sufficient Gasket Stress to Seal the Joint.* The assembly bolt stress should provide sufficient gasket stress to seat the gasket and sufficient gasket stress during operation to maintain a seal.

(b) *Damage to the Gasket.* The assembly bolt stress should not be high enough to cause over-compression (physical damage) of the gasket or excessive flange rotation of the flange, which can also lead to localized gasket over-compression.

(c) *Damage to the Bolts.* The specified bolt stress should be below the bolt yield point, such that bolt failure does not occur. In addition, the life of the bolt can be extended by specifying an even lower load.

(d) *Damage to the Flange.* The assembly bolt stress should be selected such that permanent deformation of the flange does not occur. If the flange is deformed during assembly, then it is likely that it will leak during operation or that successive assemblies will not be able to seal due to excessive flange rotation. Leakage due to flange rotation may be due to concentration of the gasket stress on the gasket outer diameter causing damage or additional relaxation. Another potential issue is the flange face outer diameter touching, which reduces the effective gasket stress.

However, it is also important to consider the practicalities involved with the in-field application of the specified bolt stress. If a different assembly stress is specified for each flange in a plant, including all variations of standard piping flanges, then it is unlikely, without a significant assembly quality assurance plan, that success will actually be improved in the field by comparison to a simpler method. Depending on the complexity of the joints in a given plant, a simple approach (standard bolt stress per size across all standard flanges, for example) may actually be more effective in preventing leakage than a more complex approach that includes consideration of the integrity of all joint components.

This Appendix outlines two approaches: the simpler single-assembly bolt stress approach (which is simpler to use, but may result in damage to joint components); and a more complex joint component-based approach that considers the integrity of each component.

### O-3 SIMPLE APPROACH

#### O-3.1 Required Information

In order to determine a standard assembly bolt stress across all flanges, it is recommended that, as a minimum, the target gasket stress,  $S_{gT}$ , for a given gasket type be considered. Further integrity issues, as outlined in the following section on the joint component approach, may also be considered, as deemed necessary.

#### O-3.2 Determining the Appropriate Bolt Stress

The appropriate bolt stress for a range of typical joint configurations may be determined via eq. (O-1).

$$S_{b_{sel}} = S_{gT} \frac{A_g}{n_b A_b} \quad (O-1)$$

The average bolt stress across the joints considered may then be selected and this value can be converted into a torque table using eq. (O-2M) for metric units or eq. (O-2) for U.S. Customary units.

$$T_b = S_{b_{sel}} K A_b \phi_b / 1\,000 \quad (O-2M)$$

$$T_b = S_{b_{sel}} K A_b \phi_b / 12 \quad (O-2)$$

An example of the type of table produced using this method is given in Table 1, which was constructed using a bolt stress of approximately 50 ksi and a nut factor,  $K$ , of approximately 0.20 with adjustments made based on industry experience. If another bolt stress or nut factor is required, then the table may be converted to the new values using eq. (O-3), where  $S_{b'_{sel}}$ ,  $T'_{b'}$ , and  $K'$  are the original values.

$$T_b = \frac{K}{K'} \frac{S_{b_{sel}}}{S_{b'_{sel}}} T'_{b'} \quad (O-3)$$

### O-4 JOINT COMPONENT APPROACH

#### O-4.1 Required Information

There are several values that must be known prior to calculating the appropriate assembly bolt stress using the joint component approach.

(a) The maximum permissible flange rotation ( $\theta_{g_{max}}$ ) at the assembly gasket stress and the gasket operating temperature must be obtained from industry test data or from the gasket manufacturer. There is presently no standard test for determining this value; however, typical limits vary from 0.3 deg for expanded PTFE gaskets to 1.0 deg for typical graphite-filled metallic gaskets (per flange). A suitable limit may be determined for a given site based on calculation of the amount of rotation that presently exists in flanges in a given service using the gasket type in question.

(b) The maximum permissible bolt stress ( $S_{b_{max}}$ ) must be selected by the user. This value is intended to eliminate damage to the bolt or assembly equipment during assembly and may vary from site to site. It is typically in the range of 40% to 70% of ambient bolt yield stress (see section 10).

(c) The minimum permissible bolt stress ( $S_{b_{min}}$ ) must be selected by the user. This value is intended to provide a lower limit such that bolting inaccuracies do not become a significant portion of the specified assembly bolt stress,  $S_{b_{sel}}$ . The value is typically in the range of 20% to 40% of ambient bolt yield stress.

(d) The maximum permissible bolt stress for the flange ( $S_{f_{max}}$ ) must be determined, based on the particular flange configuration. This may be found using either elastic closed-form solutions or elastic-plastic finite element analysis, as outlined in section O-5. In addition, when the limits are being calculated, the flange rotation at that load should also be determined ( $\theta_{f_{max}}$ ). Example flange limit loads for elastic closed-form solutions and elastic-plastic finite element solutions are outlined in Tables O-1 through O-7.

(e) The target assembly gasket stress ( $S_{gT}$ ) should be selected by the user in consultation with the gasket manufacturer. The target gasket stress should be selected to be towards the upper end of the acceptable gasket

stress range, as this will give the most amount of buffer against joint leakage.

(f) The maximum assembly gasket stress ( $S_{g_{max}}$ ) must be obtained from industry test data or from the gasket manufacturer. This value is the maximum compressive stress at the assembly temperature, based on full gasket area, which the gasket can withstand without permanent damage (excessive leakage or lack of elastic recovery) to the gasket sealing element. Any value provided should include consideration of the effects of flange rotation for the type of flange being considered in increasing the gasket stress locally on the outer diameter.

(g) The minimum gasket seating stress ( $S_{g_{min-s}}$ ) must be obtained from industry test data or from the gasket manufacturer. This value is the minimum recommended compressive stress at the assembly temperature and is based on full gasket area. The value is the stress that the gasket should be assembled to in order to obtain adequate redistribution of any filler materials and ensure an initial seal between the gasket and the flange faces.

(h) The minimum gasket operating stress ( $S_{g_{min-o}}$ ) must be obtained from industry test data or from the gasket manufacturer. This value is the minimum recommended compressive stress during operation and is based on full gasket area. This is the gasket stress that should be maintained on the gasket during operation in order to ensure the leakage does not occur.

(i) The gasket relaxation fraction ( $\varphi_g$ ) must also be obtained from industry test data or from the gasket manufacturer for the gasket in flange assemblies of similar configuration to the ones being assessed. A default value of 0.7 may be used if data are not available.

#### O-4.2 Determining the Appropriate Bolt Stress

Once the limits are defined, it is possible to utilize the following process for each joint configuration. This process can be performed using a spreadsheet or software program, which allows the determination of many values simultaneously.

*Step 1:* Determine the target bolt stress in accordance with eq. (O-1).

*Step 2:* Determine if the bolt upper limit controls

$$S_{b_{sel}} = \min. (S_{b_{sel}}, S_{b_{max}}) \quad (O-4)$$

*Step 3:* Determine if the bolt lower limit controls

$$S_{b_{sel}} = \max. (S_{b_{sel}}, S_{b_{min}}) \quad (O-5)$$

*Step 4:* Determine if the flange limit controls<sup>2</sup>

$$S_{b_{sel}} = \min. (S_{b_{sel}}, S_{f_{max}}) \quad (O-6)$$

*Step 5:* Check if the gasket assembly seating stress is achieved.

$$S_{b_{sel}} \geq S_{g_{min-s}} [A_g / (A_b n_b)] \quad (O-7)$$

*Step 6:* Check if the gasket operating stress is maintained.<sup>3</sup>

$$S_{b_{sel}} \geq (S_{g_{min-o}} A_g + \pi / 4 P_{max} G_{I.D.}^2) / (\varphi_g A_b n_b) \quad (O-8)$$

*Step 7:* Check if the gasket maximum stress is exceeded.

$$S_{b_{sel}} \leq S_{g_{max}} [A_g / (A_b n_b)] \quad (O-9)$$

*Step 8:* Check if the flange rotation limit is exceeded.

$$S_{b_{sel}} \leq S_{f_{max}} (\theta_{g_{max}} / \theta_{f_{max}}) \quad (O-10)$$

If one of the final checks (Steps 5 through 8) is exceeded, then judgment should be used to determine which controlling limit is more critical to integrity and, therefore, what the selected bolt load ought to be. A table of assembly bolt torque values can then be calculated using eq. (O-2M) or (O-2). An example table of assembly bolt stresses and torque values using this approach is outlined in Tables O-8 and O-9, respectively.

#### O-4.3 Example Calculation

NPS 3 Class 300 Flange Operating at Ambient Temperature (Identical Limits Used as Those in Table O-8) with nut factor per Table O-9

$$A_b = 0.3019 \text{ in.}^2$$

$$n_b = 8$$

$$A_b \cdot n_b = 2.42 \text{ in.}^2$$

$$A_g = 5.17 \text{ in.}^2$$

$$\phi_b = 0.75 \text{ in.}$$

$$P_{max.} = 750 \text{ psig (0.75 ksi)}$$

$$\varphi_g = 0.7$$

$$G_{I.D.} = 4.19 \text{ in.}$$

<sup>2</sup> In some cases (e.g., high temperature stainless steel flanges) the yield strength of the flange may reduce significantly during operation. In those cases, the flange limit should be reduced by the ratio of the yields ( $S_{f_{max}} S_{yo} / S_{ym}$ ). A useful ratio for determining if this adjustment must be performed is to compare the reduction in yield to the amount of relaxation occurring and if the reduction ratio exceeds the relaxation, the effect should be included. This check is expressed as follows: the reduction factor should be included if  $(S_{yo} / S_{ym}) < 1.25 \varphi_g$ . The additional reduction in gasket relaxation (1.25 term) is included to capture possible variances in actual relaxation versus test or assumed values.

<sup>3</sup> Note that this simple treatment does not take into account the changes in bolt load during operation due to component elastic interaction. A more complex relationship for the operational gasket stress may be used in lieu of this equation that includes the effects of elastic interaction in changing the bolt stress.



*Determine Bolt Stress:*

Equation (O-1):  $Sb_{sel} = 30(5.17/2.42) = 64 \text{ ksi}$

Equation (O-4):  $Sb_{sel} = \min. (64, 75) = 64 \text{ ksi}$

Equation (O-5):  $Sb_{sel} = \max. (64, 35) = 64 \text{ ksi}$

Table O-2:  $Sf_{max} = 63 \text{ ksi}$  (note:  $S_{yo} = S_{ya}$ )

Equation (O-6):  $Sb_{sel} = \min. (64, 63) = 63 \text{ ksi}$

*Additional Checks:*

Equation (O-7):  $Sb_{sel} \geq 12.5 (5.17/2.42) \geq 26.7 \text{ ksi} \checkmark$

Equation (O-8):  $Sb_{sel} \geq (6.0 \times 5.17 + \pi/4 \times 0.75 \times 4.19^2)/(0.7 \times 2.42) \geq 24 \text{ ksi} \checkmark$

Equation (O-9):  $Sb_{sel} \leq 40 (5.17/2.42) \leq 85 \text{ ksi} \checkmark$

Table O-4:  $\theta_{max} = 0.32 \text{ deg}$

Equation (O-10):  $Sb_{sel} \leq 63 (1.0/0.32) \leq 197 \text{ ksi} \checkmark$

Equation (O-2):  $T_b = 63,000 \times 0.2 \times 0.3019 \times 0.75/12$   
 $T_b \approx 240 \text{ ft-lb}$

Note that for some flanges (NPS 8, class 150 for example) the additional limits [eq. (O-7) onward] are not satisfied. In those cases, engineering judgment should be used to determine which limits are more critical to the joint integrity, and the value of  $Sb_{sel}$  should be modified accordingly. It should be noted that the values presented are not hard limits (i.e., flange leakage will not occur if the gasket stress falls 0.1 psi below the limit) and therefore some leeway in using the values is to be considered normal.

**O-5 DETERMINING FLANGE LIMITS****O-5.1 Elastic Analysis**

A series of elastic analysis limits have been determined that allow the calculation of the approximate assembly bolt stress that will cause significant permanent deformation of the flange. Since this bolt stress is approximate, and the flange material yield tends to be lower bound, it is considered appropriate to use these limits without modification or additional safety factor. An explanation of the limits and equations used to determine the bolt stress can be found in WRC Bulletin 538.

**O-5.2 Finite Element Analysis**

A more accurate approach to determining the appropriate limit on assembly bolt load is to analyze the joint using elastic-plastic nonlinear Finite Element Analysis (FEA). An explanation of the requirements for performing such an analysis are outlined in WRC Bulletin 538. It is not necessary to rerun the analysis for minor changes to the joint configuration (such as different gasket dimensions or minor changes to the flange material yield strength) as linear interpolation using the ratio of the change in gasket moment arm or ratio of the different yield strength can be used to estimate the assembly bolt stress limit for the new case.

**Table O-1M Pipe Wall Thickness Used for Following Tables (mm)**

NPS	Class					
	150	300	600	900	1500	2500
2	1.65	1.65	3.91	2.77	5.54	8.74
2½	2.11	2.11	3.05	5.16	7.01	14.02
3	2.11	2.11	3.05	5.49	7.62	15.24
4	2.11	2.11	6.02	6.02	11.13	17.12
5	2.77	2.77	6.55	9.52	12.70	19.05
6	2.77	2.77	7.11	10.97	14.27	23.12
8	2.77	3.76	8.18	12.70	20.62	30.10
10	3.40	7.80	12.70	15.09	25.40	37.49
12	3.96	8.38	12.70	17.48	28.58	44.47
14	3.96	6.35	12.70	19.05	31.75	...
16	4.19	7.92	14.27	23.83	34.93	...
18	4.78	9.53	20.62	26.19	44.45	...
20	4.78	9.53	20.62	32.54	44.45	...
24	5.54	14.27	24.61	38.89	52.37	...
26	7.92	12.70	23.73	35.09	...	...
28	7.92	12.70	25.56	37.79	...	...
30	6.35	15.88	27.38	40.49	...	...
32	7.92	15.88	29.21	43.19	...	...
34	7.92	15.88	31.03	45.89	...	...
36	7.92	19.05	32.86	48.59	...	...
38	9.53	17.60	34.69	51.29	...	...
40	9.53	18.52	36.51	53.99	...	...
42	9.53	19.45	38.34	56.69	...	...
44	9.53	20.37	40.16	59.39	...	...
46	9.53	21.30	41.99	62.09	...	...
48	9.53	22.23	43.81	64.79	...	...

**Table O-1 Pipe Wall Thickness Used for Following Tables (in.)**

NPS	Class					
	150	300	600	900	1500	2500
2	0.065	0.065	0.154	0.109	0.218	0.344
2½	0.083	0.083	0.120	0.203	0.276	0.552
3	0.083	0.083	0.120	0.216	0.300	0.600
4	0.083	0.083	0.237	0.237	0.438	0.674
5	0.109	0.109	0.258	0.375	0.500	0.750
6	0.109	0.109	0.280	0.432	0.562	0.910
8	0.109	0.148	0.322	0.500	0.812	1.185
10	0.134	0.307	0.500	0.594	1.000	1.476
12	0.156	0.330	0.500	0.688	1.125	1.751
14	0.156	0.250	0.500	0.750	1.250	...
16	0.165	0.312	0.562	0.938	1.375	...
18	0.188	0.375	0.812	1.031	1.750	...
20	0.188	0.375	0.812	1.281	1.750	...
24	0.218	0.562	0.969	1.531	2.062	...
26	0.312	0.500	0.934	1.382	...	...
28	0.312	0.500	1.006	1.488	...	...
30	0.250	0.625	1.078	1.594	...	...
32	0.312	0.625	1.150	1.700	...	...
34	0.312	0.625	1.222	1.807	...	...
36	0.312	0.750	1.294	1.913	...	...
38	0.375	0.693	1.366	2.019	...	...
40	0.375	0.729	1.437	2.126	...	...
42	0.375	0.766	1.509	2.232	...	...
44	0.375	0.802	1.581	2.338	...	...
46	0.375	0.839	1.653	2.444	...	...
48	0.375	0.875	1.725	2.551	...	...

**Table O-2M Bolt Stress Limit for SA-105 Steel Flanges Using Elastic-Plastic FEA (MPa)**  
ASME B16.5 and B16.47 Series A – Weldneck

NPS	Class					
	150	300	600	900	1500	2500
2	579	398	579	434	471	471
2½	688	326	434	398	471	543
3	724	434	615	579	471	579
4	543	615	688	434	507	507
5	543	724	652	507	543	543
6	724	579	579	579	615	579
8	724	579	615	507	579	579
10	579	543	543	507	615	579
12	724	543	507	543	579	615
14	579	434	471	543	543	...
16	543	434	471	579	507	...
18	724	471	579	543	543	...
20	615	507	507	579	507	...
24	615	471	507	543	507	...
26	253	253	362	434	...	...
28	217	253	326	398	...	...
30	253	290	434	434	...	...
32	217	253	398	434	...	...
34	190	290	434	398	...	...
36	217	253	398	434	...	...
38	253	579	579	543	...	...
40	217	543	615	543	...	...
42	253	543	615	579	...	...
44	226	579	615	543	...	...
46	253	615	652	543	...	...
48	253	507	579	579	...	...

**Table O-2 Bolt Stress Limit for SA-105 Steel Flanges Using Elastic-Plastic FEA (ksi)**  
ASME B16.5 and B16.47 Series A – Weldneck

NPS	Class					
	150	300	600	900	1500	2500
2	84	58	84	63	68	68
2½	100	47	63	58	68	79
3	105	63	89	84	68	84
4	79	89	100	63	74	74
5	79	105	95	74	79	79
6	105	84	84	84	89	84
8	105	84	89	74	84	84
10	84	79	79	74	89	84
12	105	79	74	79	84	89
14	84	63	68	79	79	...
16	79	63	68	84	74	...
18	105	68	84	79	79	...
20	89	74	74	84	74	...
24	89	68	74	79	74	...
26	37	37	53	63	...	...
28	32	37	47	58	...	...
30	37	42	63	63	...	...
32	32	37	58	63	...	...
34	28	42	63	58	...	...
36	32	37	58	63	...	...
38	37	84	84	79	...	...
40	32	79	89	79	...	...
42	37	79	89	84	...	...
44	33	84	89	79	...	...
46	37	89	95	79	...	...
48	37	74	84	84	...	...

**Table O-3 Flange Rotation for SA-105  
Steel Flanges Loaded to Table O-2M/O-2  
Bolt Stress Using Elastic-Plastic FEA (deg)**

NPS	Class					
	150	300	600	900	1500	2500
2	0.37	0.34	0.23	0.21	0.20	0.16
2½	0.36	0.31	0.24	0.20	0.21	0.17
3	0.23	0.32	0.26	0.26	0.22	0.16
4	0.50	0.37	0.29	0.26	0.21	0.17
5	0.56	0.33	0.29	0.28	0.20	0.17
6	0.61	0.41	0.30	0.27	0.21	0.16
8	0.46	0.45	0.31	0.28	0.21	0.17
10	0.70	0.43	0.34	0.30	0.21	0.17
12	0.74	0.48	0.35	0.34	0.22	0.16
14	0.68	0.48	0.39	0.33	0.24	...
16	0.83	0.48	0.39	0.34	0.23	...
18	0.88	0.51	0.41	0.33	0.24	...
20	0.87	0.58	0.40	0.32	0.24	...
24	0.95	0.59	0.41	0.31	0.26	...
26	0.87	0.59	0.43	0.35	...	...
28	0.84	0.50	0.40	0.37	...	...
30	0.97	0.60	0.43	0.35	...	...
32	0.98	0.49	0.48	0.37	...	...
34	0.87	0.52	0.41	0.35	...	...
36	0.85	0.51	0.44	0.38	...	...
38	1.09	0.51	0.39	0.34	...	...
40	0.93	0.52	0.43	0.37	...	...
42	1.04	0.60	0.43	0.35	...	...
44	0.91	0.54	0.43	0.35	...	...
46	1.00	0.52	0.43	0.37	...	...
48	1.04	0.63	0.42	0.35	...	...

**Table O-4M Bolt Stress Limit for SA-105  
Steel Flanges Using Elastic Closed Form Analysis  
(MPa)**

ASME B16.5 and B16.47 Series A — Weldneck

NPS	Class					
	150	300	600	900	1500	2500
2	450	310	515	332	413	447
2½	576	284	388	377	441	496
3	724	394	545	517	432	531
4	445	561	633	417	492	454
5	402	724	663	468	528	501
6	541	593	630	543	605	535
8	724	614	657	463	576	557
10	503	639	566	444	627	543
12	712	607	563	494	554	594
14	583	454	513	526	485	...
16	563	398	508	532	487	...
18	614	472	594	534	521	...
20	568	451	482	545	501	...
24	479	365	450	546	481	...
26	218	242	359	448	...	...
28	193	264	354	399	...	...
30	228	290	447	465	...	...
32	173	272	396	460	...	...
34	160	296	463	418	...	...
36	207	261	404	436	...	...
38	211	557	623	551	...	...
40	199	536	634	532	...	...
42	218	581	626	585	...	...
44	221	676	638	570	...	...
46	238	724	687	563	...	...
48	222	524	605	625	...	...

ASME B16.5 — Slip-On						
NPS	Class					
	150	300	600	900	1500	
2	724	360	572	423	413	
2½	534	321	410	377	441	
3	714	446	563	518	...	
4	394	594	601	467	...	
5	446	678	507	492	...	
6	603	458	495	536	...	
8	724	538	515	456	...	
10	477	472	430	429	...	
12	674	476	421	468	...	
14	445	283	344	504	...	
16	453	320	370	509	...	
18	561	376	546	514	...	
20	487	428	499	524	...	
24	535	395	500	528	...	

**Table O-4 Bolt Stress Limit for SA-105 Steel Flanges Using Elastic Closed Form Analysis (ksi)**

ASME B16.5 and B16.47 Series A — Weldneck

NPS	Class					
	150	300	600	900	1500	2500
2	65	45	75	48	60	65
2½	83	41	56	55	64	72
3	105	57	79	75	63	77
4	65	81	92	61	71	66
5	58	105	96	68	77	73
6	78	86	91	79	88	78
8	105	89	95	67	83	81
10	73	93	82	64	91	79
12	103	88	82	72	80	86
14	84	66	74	76	70	...
16	82	58	74	77	71	...
18	89	69	86	77	76	...
20	82	65	70	79	73	...
24	69	53	65	79	70	...
26	32	35	52	65	...	...
28	28	38	51	58	...	...
30	33	42	65	67	...	...
32	25	40	58	67	...	...
34	23	43	67	61	...	...
36	30	38	59	63	...	...
38	31	81	90	80	...	...
40	29	78	92	77	...	...
42	32	84	91	85	...	...
44	32	98	93	83	...	...
46	35	105	100	82	...	...
48	32	76	88	91	...	...

**ASME B16.5 — Slip-On**

NPS	Class				
	150	300	600	900	1500
2	105	52	83	61	60
2½	77	47	60	55	64
3	103	65	82	75	...
4	57	86	87	68	...
5	65	98	74	71	...
6	87	66	72	78	...
8	105	78	75	66	...
10	69	68	62	62	...
12	98	69	61	68	...
14	65	41	50	73	...
16	66	46	54	74	...
18	81	55	79	75	...
20	71	62	72	76	...
24	78	57	73	77	...

**Table O-5 Flange Rotation for SA-105 Steel Flanges Loaded to Table O-4M/O-4 Bolt Stress Using Elastic Closed Form Analysis (deg)**

ASME B16.5 and B16.47 Series A — Weldneck

NPS	Class					
	150	300	600	900	1500	2500
2	0.20	0.20	0.15	0.13	0.09	0.08
2½	0.22	0.19	0.17	0.11	0.09	0.07
3	0.20	0.22	0.19	0.15	0.12	0.08
4	0.28	0.27	0.19	0.17	0.14	0.10
5	0.29	0.26	0.20	0.18	0.14	0.10
6	0.33	0.32	0.24	0.16	0.15	0.10
8	0.35	0.36	0.28	0.18	0.15	0.11
10	0.44	0.40	0.27	0.17	0.16	0.10
12	0.46	0.42	0.32	0.21	0.15	0.11
14	0.46	0.38	0.35	0.24	0.15	...
16	0.54	0.36	0.36	0.23	0.17	...
18	0.54	0.41	0.34	0.26	0.18	...
20	0.60	0.39	0.33	0.24	0.19	...
24	0.59	0.37	0.34	0.26	0.20	...
26	0.77	0.55	0.42	0.33	...	...
28	0.79	0.56	0.43	0.33	...	...
30	0.88	0.58	0.42	0.34	...	...
32	0.84	0.58	0.43	0.34	...	...
34	0.85	0.57	0.43	0.34	...	...
36	0.90	0.56	0.43	0.34	...	...
38	0.93	0.71	0.48	0.35	...	...
40	0.93	0.71	0.48	0.35	...	...
42	0.94	0.71	0.48	0.36	...	...
44	0.96	0.71	0.48	0.36	...	...
46	0.98	0.71	0.48	0.36	...	...
48	0.95	0.71	0.48	0.36	...	...

**ASME B16.5 — Slip-On**

NPS	Class				
	150	300	600	900	1500
2	0.34	0.28	0.21	0.14	0.10
2½	0.35	0.29	0.24	0.12	0.10
3	0.40	0.32	0.27	0.21	...
4	0.52	0.38	0.27	0.21	...
5	0.64	0.43	0.30	0.20	...
6	0.73	0.49	0.33	0.20	...
8	0.84	0.57	0.38	0.22	...
10	1.02	0.59	0.40	0.27	...
12	1.09	0.66	0.47	0.33	...
14	1.14	0.70	0.50	0.33	...
16	1.26	0.76	0.52	0.33	...
18	1.34	0.80	0.52	0.34	...
20	1.38	0.86	0.55	0.33	...
24	1.52	0.91	0.58	0.33	...

**Table O-6M Bolt Stress Limit for SA-182 F304 Steel Flanges Using Elastic-Plastic FEA (MPa)**  
ASME B16.5 and B16.47 Series A – Weldneck

NPS	Class					
	150	300	600	900	1500	2500
2	434	326	471	362	362	398
2½	543	253	362	326	398	434
3	724	362	507	471	362	471
4	362	471	543	362	434	434
5	398	615	543	398	434	434
6	543	471	471	471	471	471
8	579	471	507	434	471	471
10	434	434	434	434	507	471
12	471	434	434	434	471	507
14	434	326	362	434	434	...
16	362	362	362	471	434	...
18	398	398	471	471	434	...
20	362	398	398	471	434	...
24	362	362	398	434	398	...
26	217	181	290	362	...	...
28	181	217	290	326	...	...
30	217	217	362	362	...	...
32	181	217	326	362	...	...
34	172	253	362	326	...	...
36	181	217	326	362	...	...
38	181	471	471	434	...	...
40	145	434	507	434	...	...
42	217	434	507	471	...	...
44	154	471	471	434	...	...
46	217	507	507	434	...	...
48	217	398	471	471	...	...

**Table O-6 Bolt Stress Limit for SA-182 F304 Steel Flanges Using Elastic-Plastic FEA (ksi)**  
ASME B16.5 and B16.47 Series A – Weldneck





NPS	Class					
	150	300	600	900	1500	2500
2	63	47	68	53	53	58
2½	79	37	53	47	58	63
3	105	53	74	68	53	68
4	53	68	79	53	63	63
5	58	89	79	58	63	63
6	79	68	68	68	68	68
8	84	68	74	63	68	68
10	63	63	63	63	74	68
12	68	63	63	63	68	74
14	63	47	53	63	63	...
16	53	53	53	68	63	...
18	58	58	68	68	63	...
20	53	58	58	68	63	...
24	53	53	58	63	58	...
26	32	26	42	53	...	...
28	26	32	42	47	...	...
30	32	32	53	53	...	...
32	26	32	47	53	...	...
34	25	37	53	47	...	...
36	26	32	47	53	...	...
38	26	68	68	63	...	...
40	21	63	74	63	...	...
42	32	63	74	68	...	...
44	22	68	68	63	...	...
46	32	74	74	63	...	...
48	32	58	68	68	...	...

**Table O-7 Flange Rotation for SA-182 F304  
Steel Flanges Loaded to Table O-6M/O-6  
Bolt Stress Using Elastic-Plastic FEA (deg)**

NPS	Class					
	150	300	600	900	1500	2500
2	0.47	0.34	0.21	0.17	0.15	0.16
2½	0.40	0.29	0.20	0.20	0.24	0.13
3	0.21	0.27	0.29	0.23	0.16	0.12
4	0.55	0.41	0.25	0.21	0.19	0.15
5	0.61	0.32	0.27	0.25	0.20	0.18
6	0.64	0.38	0.27	0.24	0.17	0.15
8	0.46	0.42	0.34	0.25	0.19	0.15
10	0.91	0.47	0.26	0.26	0.17	0.15
12	0.79	0.37	0.31	0.26	0.20	0.17
14	0.89	0.41	0.28	0.25	0.19	...
16	1.02	0.41	0.29	0.31	0.20	...
18	0.93	0.54	0.28	0.25	0.18	...
20	1.02	0.53	0.35	0.29	0.20	...
24	1.12	0.44	0.37	0.24	0.23	...
26	0.81	0.53	0.33	0.29	...	...
28	0.52	0.45	0.37	0.25	...	...
30	0.91	0.41	0.35	0.29	...	...
32	0.59	0.43	0.31	0.31	...	...
34	0.68	0.37	0.34	0.24	...	...
36	0.54	0.44	0.30	0.31	...	...
38	1.00	0.46	0.35	0.26	...	...
40	0.91	0.55	0.35	0.28	...	...
42	0.52	0.64	0.34	0.32	...	...
44	0.54	0.48	0.34	0.27	...	...
46	1.00	0.55	0.41	0.28	...	...
48	0.51	0.55	0.38	0.32	...	...

**Table O-8 Example Bolt Stress for SA-105 Steel Weldneck Flanges, SA-193 B7 Steel Bolts, and Spiral-Wound Gasket With Inner Ring (ksi)**

Calculated Bolt Stress (ksi)						
NPS	150	300	600	900	1500	2500
2	75	56	56	43	43	35
2½	75	44	44	40	40	35
3	75	63	64	60	38	35
4	75	75	75	49	42	35
5	75	75	75	48	36	35
6	75	75	74	56	38	35
8	75	75	75	44	35	35
10	75	75	62	40	35	35
12	75	75	66	49	35	35
14	75	63	54	44	35	
16	75	63	58	42	35	
18	75	68	62	45	35	
20	75	74	57	38	35	
24	75	68	50	35	35	
26	37	37	41	35		
28	35	37	38	35		
30	37	42	41	35		
32	35	37	35	35		
34	35	42	36	35		
36	35	37	35	35		
38	37	75	39	35		
40	35	68	36	35		
42	37	71	35	35		
44	35	68	35	35		
46	37	69	35	35		
48	37	63	35	35		

-  = limited by min. bolt stress
-  = limited by max. bolt stress
-  = limited by max. gasket stress
-  = limited by max. flange stress

Example Limits Used in Analysis:

$$Sb_{\min} = 35 \text{ ksi}$$

$$Sb_{\max} = 75 \text{ ksi}$$

$$Sf_{\max} = \text{from Table O-2}$$

$$Sg_t = 30 \text{ ksi}$$

$$Sg_{\max} = 40 \text{ ksi}$$

$$Sg_{\min-S} = 12.5 \text{ ksi}$$

$$Sg_{\min-O} = 6 \text{ ksi}$$

$$\theta g_{\max} = 1.0 \text{ deg}$$



**Table O-9 Example Assembly Bolt Torque for SA-105 Steel Weldneck Flanges, SA-193 B7 Steel Bolts, and Spiral-Wound Gasket With Inner Ring (ft-lb)**

NPS	150	300	600	900	1500	2500
2	160	120	120	265	265	325
2½	160	170	170	370	370	480
3	160	240	245	370	520	680
4	160	285	460	665	810	1,230
5	285	285	690	935	1,275	2,025
6	285	285	680	765	1,015	3,095
8	285	460	1,025	1,175	1,615	3,095
10	460	690	1,210	1,070	2,520	6,260
12	460	1,025	1,270	1,290	3,095	8,435
14	690	860	1,430	1,540	4,495	...
16	690	1,220	2,035	1,915	6,260	...
18	1,025	1,325	2,825	3,210	8,435	...
20	1,025	1,425	2,590	3,380	11,070	...
24	1,455	2,400	3,570	6,260	17,865	...
26	715	1,675	2,950	8,435	...	...
28	680	1,675	3,370	11,070	...	...
30	715	2,425	3,620	11,070	...	...
32	1,230	2,645	4,495	14,195	...	...
34	1,230	3,025	4,610	17,865	...	...
36	1,230	3,250	6,260	17,865	...	...
38	1,295	2,635	5,050	17,865	...	...
40	1,230	3,085	4,670	17,865	...	...
42	1,295	3,230	6,260	17,865	...	...
44	1,230	3,910	6,260	22,120	...	...
46	1,295	4,985	6,260	27,000	...	...
48	1,295	4,570	8,435	27,000	...	...

## GENERAL NOTES:

- (a) Nut factor used:  $K = 0.2$ .  
(b) Torque rounded up to nearest 5 ft-lb.

# APPENDIX P

## GUIDANCE ON TROUBLESHOOTING FLANGED JOINT LEAKAGE INCIDENTS

### P-1 INTRODUCTION

The performance of a pressurized, gasketed, bolted flanged joint, either standard or Code designed, is measured in terms of its ability to remain leak free through all anticipated plant operations. When a leak occurs, whether minor or major, it is prudent and beneficial to perform a rigorous investigation to uncover the cause and understand why.

### P-2 SCOPE

This Appendix is intended to assist flanged joint troubleshooting efforts by providing

- (a) an investigative and diagnostic evaluation guide to characterize the joint in terms of its historical, operating, and mechanical status
- (b) a sample “Flanged Joint Leak Report”
- (c) a checklist of flange design and acceptable practice considerations
- (d) a set of problem and potential solution diagnostic troubleshooting tables

### P-3 INVESTIGATIVE AND DIAGNOSTIC EVALUATION GUIDE

Troubleshooting a flanged joint leak is a process that may involve some or all of the following evaluations (in no particular order).

#### P-3.1 Operating History

Time in service overall — general history

- (a) Time in service since previous problem, if not new
- (b) Timing of leak — where in operating cycle (start-up, shutdown, upset, normal run cycle, foul weather)
- (c) Nature of leak (single or multiple locations around joint: drip, vapor, flow intermittent, constant, extreme, or catastrophic)
- (d) Nature of previous difficulties, evaluation summaries, and fixes such as reports, practice (system operation and maintenance) changes
- (e) Prior assembly records and procedure
- (f) Last applied bolt load: How much? Applied by what means? Measured by what means? When?

#### P-3.2 Operating Conditions

- (a) Atmospheric: unremarkable, heavy rain, high wind, very cold, etc.

- (b) Normal temperature, pressure, service fluid, flow rate, and/or other loadings.

- (c) Anticipated upset temperatures, pressures, flow rate, and/or other loadings.

- (d) Known but unanticipated upset temperatures, pressures, flow rate, and/or other loadings including fluid hammer effects.

- (e) Recent changes of any kind (process, flow rate, service fluid, or other) — meet, discuss with management and operating personnel.

- (f) Actual vessel, flange, and bolt temperatures as measured with best available means such as contact thermometer, infrared, indicating crayon, etc. (not the process operating gages).

- (g) Removal or application of insulation to joint or bolts while operating.

- (h) Human error, other factors, time of day or shift, training.

#### P-3.3 Attempts to Correct

- (a) Hot bolting attempts? Online or while line temporarily isolated? Number of, method, and result for each.

- (b) Gasket replacement attempts — result? In kind or different gasket?

- (c) Sealant injection attempts — number of, method, and result for each.

#### P-3.4 Physical Condition, Inspection, and Maintenance (Refer to Form P-3.4, Sample Flange Joint Leak Report)

- (a) Previous inspection, maintenance records.

- (b) Physical changes, layout, support, environmental.

- (c) Physical disassembly observations; were there loose or near loose bolts? How many? Relationship to leak? Gasket compression and condition? Signs of galling at nut face or on bolts?

- (d) Location of joint: near nozzle or other fixed point? Proper support? Restraint of thermal expansion OK?

- (e) Facing condition (corrosion, warping, weld spatter, leakage path, wire draw?).

- (f) Leakage onto the joint from another source creating corrosion or DTE (differential thermal expansion) problems?

- (g) Has flange been altered such as nubbin removed or RTJ gasket converted to spiral wound on RF?

**Form P-3.4 Sample Flange Joint Leak Report**

1. Date: \_\_\_\_\_
2. Unit: \_\_\_\_\_
3. Equipment: \_\_\_\_\_
4. Joint identification: \_\_\_\_\_
5. ISO or Drawing no.: \_\_\_\_\_
6. Flange size/ pressure class: \_\_\_\_\_
7. Gasket material / type \_\_\_\_\_
8. Flange temp./ bolt temp.: \_\_\_\_\_
9. Describe: Leak type: (wisp, drops, stream, emissions)
10. Leak timing (@hydro; @first startup; @later startups; @cool down; @\_\_ months operation; Other \_\_\_\_\_)
11. Bolt lubricant condition: \_\_\_\_\_
12. Describe the use of the joint: i.e., channel cover \_\_\_\_\_
13. Circle the best descriptive location and orientation.

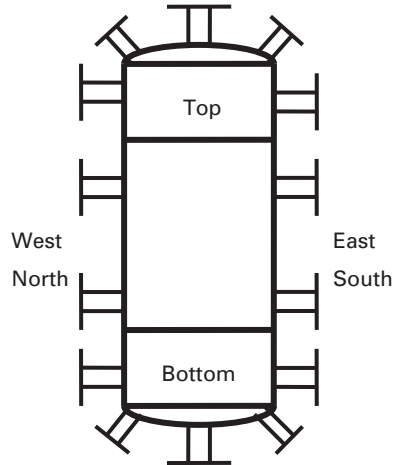
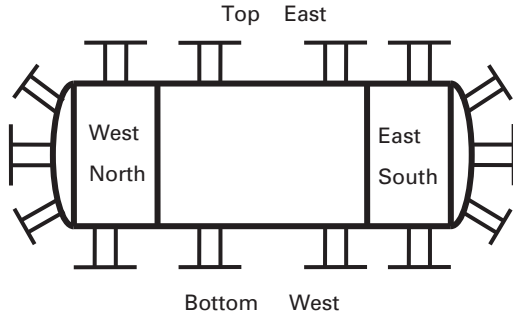

**Piping Joints**

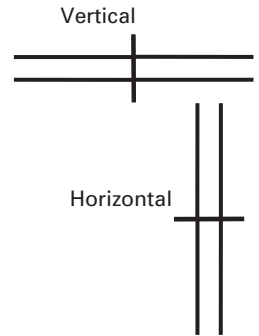

14. Mark the leak location.

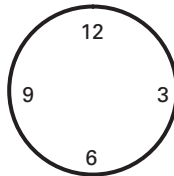

15. Measure the gap between the flanges at four locations.

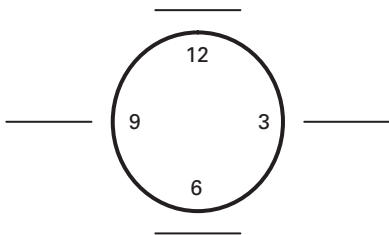

Measure eight locations for flanges larger than 30 in.

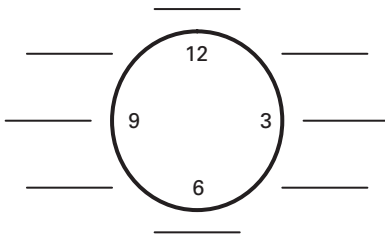

Measure the flange offset at four locations.

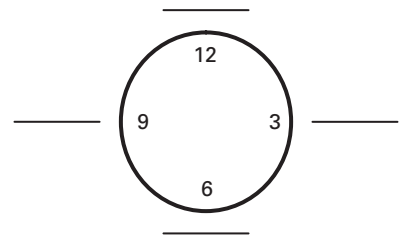

16. Measure the torque it takes to move the nuts.

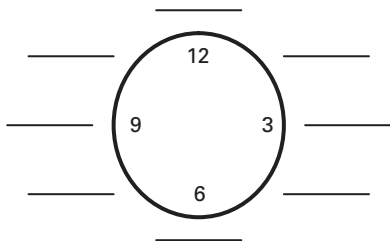

Record applied torque during tightening.

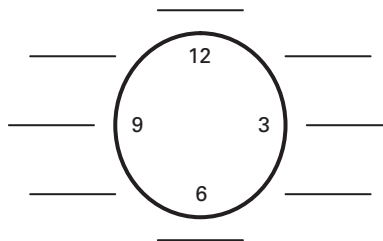

17. Mark nuts with the following marks after applying torque:

18. Leakage status: No change \_\_ Reduced \_\_ Stopped \_\_

19. Adverse conditions: \_\_\_\_\_

20. Comments: \_\_\_\_\_

Nuts do not turn = 0

Nuts turn slightly = X

Nuts turn = XX

Nuts turn very easily = XXX

21. Recommendations: \_\_\_\_\_

22. Names: \_\_\_\_\_

23. Signatures: \_\_\_\_\_

(h) Is the flange within minimum thickness requirements? (Check flanged joint standard or Code calculation.)

(i) Flange alignment measurements — current and previous?

(j) Support (or lack of) for external loadings (weight or thermal).

(k) Are the bolts and/or flanges insulated? Condition of insulation? Condition of portable pads (removable insulation pads)?

(l) Same effective length for all bolts? Example of different effective lengths would be a heat exchanger tubesheet joint where the tubesheet has some but not all holes threaded for retaining the tubesheet to shell seal when removing the channel for inspection and cleaning. The threaded tubesheet creates a different effective bolt length as it functions as a nut in the middle of the bolt. Refer to para. P-4.2.

### P-3.5 Previous Assembly Practices

(a) Assembler qualifications, training.

(b) Assembly procedures and/or ASME PCC-1 conformance.

(c) Assembler access — e.g., poor tool access, ineffective staging, nut socket fit, etc.

(d) Ability to access the joint to perform the assembly. Assembly tooling employed.

### P-3.6 Specifications Conformance

(a) Gasket

(b) Hardware (bolts/studs, nuts, washers; were washers through-hardened?), flanges.

(c) Conformance of support arrangements (or lack of) for external loads (weight, dynamic or thermal), and piping thermal expansion restraint arrangement.

## P-4 CHECKLIST OF FLANGE DESIGN AND ACCEPTABLE PRACTICE CONSIDERATIONS

A well-assembled joint cannot function as intended, and the correct clamping force cannot be created if the design, the specification, or the fabrication, including the gasket, are faulty. Because of the interactions, interdependencies, and interrelationships that are inherent in a bolted joint assembly, the performance of a properly assembled bolted joint assembly is contingent upon many choices made and activities performed within acceptable limits.

The design and practice checklist below is a tool intended to assist the troubleshooter in spotting potential problems associated with a particular joint. It applies to both standard piping joints and Code-designed flanged joints (as noted) that have experienced chronic leakage.

### P-4.1 Loading Effects

Often a flanged joint is designed (or selected) for internal system pressure loadings only, whereas in reality significant external forces, pressure surge, and thermal loadings may occur and affect the gasket load and joint tightness.

#### P-4.1.1 External Bending or Axial Force

(a) Review design documents and calculations for any specified additional forces and compare these with current operating circumstances. Consider the reactions of piping systems against nozzles and vessel joints.

(b) Review against design documents the actual piping system layout, support, guides, and constraints for sources of unanticipated bending or axial forces. Consider the effect of unintended restraint of piping thermal expansion in terms of forces and bending moments.

(c) Evaluate the effect of external loads on the joint. Reference [1] and its references provide methodology for the evaluation of external loadings on pressurized flanged joints. Public computer programs exist that are fully capable of evaluating external loadings on flanged joints.

(d) Although not specifically referenced in Appendix 2 of Section VIII, Division 1 of the Boiler and Pressure Vessel Code, the requirement that all loads be considered is covered in Code para. UG-22 which, if considered, will diminish the likelihood of leakage.

**P-4.1.2 Differential Thermal Expansion (DTE).** Differential thermal expansion between the bolts and flanges is present in all joints operating at non-ambient temperatures. Both axial and radial effects on flange components must be considered. Generally, when the coefficients of expansion of flanges and bolting are closely matched, properly assembled joints with an operating fluid temperature less than about 260°C (500°F) should withstand normal start-ups and shutdowns.

**P-4.1.3 Pressure Surge.** Flanged joints within systems subject to pressure surge should be reviewed to ascertain the consistency of restraints and anchors for both DTE and surge loads.

### P-4.2 Joint Flexibility Issues

Generally speaking, strong and long bolts provide for more flexible joints as will a joint with two flanges as opposed to a single flange joint. A more flexible joint will withstand more abuse such as DTE loads. Stronger bolts also permit higher assembly loads if needed.

**P-4.2.1 Single Flange Joints.** Flange joints consisting of a single flange with bolts threaded into tapped holes are inherently less flexible and generally more troublesome because they are less tolerant of gasket thickness loss, or relaxation, and DTE effects because of the shorter effective stretching length of the bolts. Such joints are roughly twice as stiff as a normal two-flange

joint of the same size and rating and therefore will suffer roughly twice the bolt load loss for each 0.001 in. loss of gasket thickness (post assembly).

**P-4.2.2 Increasing Bolt Flexibility.** Consider increasing bolt flexibility with extension collars and longer bolts to increase effective length if necessary. (Effective stretching length is normally calculated as the distance between nut contact faces plus one bolt diameter.)

**P-4.2.3 Flange Rigidity.** Flange rigidity should meet ASME Code requirements for best joint performance [see para. 2-14(a) of Section VIII, Division 1] unless acceptable successful experience indicates otherwise. Consider the addition of split backing rings to increase rigidity for existing flanges to limit excessive flange rotation.

### P-4.3 Bolting Material Considerations

(a) If yielding of low strength bolts is evident (or predictable by computation), the use of high strength bolting to allow a greater target bolt prestress should be considered. For example, SA-193 B7, SA-193 B16, SB-637 (Alloy N07718), etc.

(b) Match coefficients of expansion of flange and bolting as closely as possible (see P-4.1.2).

(c) Employ and design for high strength bolting [e.g., SA-193 B7, SA-193 B16, SB-637 (Alloy N07718), etc.], to allow 345 MPa (50 ksi) or greater target bolt prestress.

(d) If stainless steel bolting is required, SA-453 Grade 660 is the best choice since it has the strength properties to allow a 345 MPa (50 ksi) target bolt prestress.

(e) Avoid use of low-strength SA-193 B8 Class 1 stainless steel bolts. These will most likely result in unacceptably low assembly loads. Strain-hardened SA-193 B8 Class 2 bolts will provide better results.

### P-4.4 Bolt Spacing Considerations

(a) Check minimum bolt spacing based on wrench clearance considerations to confirm accessibility.

(b) Low gasket stress can result from excessive bolt spacing. Bolt spacing for non-standard flanges should normally not exceed 2 times bolt diameter plus 6 times the flange thickness divided by the quantity  $(m + 0.5)$ , where  $m$  is the Section VIII, Division 1, Appendix 2 gasket factor. Use  $m = S_{mo}/\text{pressure}$  where tightness based gasket constants are used as in References [2] and [3].

### P-4.5 Gasket Considerations

#### P-4.5.1 Gasket Selection

(a) Spiral-wound gaskets in nominal sizes greater than 600 mm (24 in.) are fragile and must be carefully handled. Consider an inner ring.

(b) Conventional double-jacketed gasket designs, regardless of filler material, have proven to be problematic in joints subjected to differential radial movement

of the flanges, such as in tubesheet joints on shell-and-tube heat exchangers. This is due to destruction of the metal jacket or increased gasket stress relaxation due to wear of the metal jacket. Both of these failure mechanisms are caused by the differential radial movement (radial shear) of the flange seating surfaces, thereby exacerbating the inherent poor sealability characteristics of the gasket.

(c) Gasket styles that are provided with a flexible graphite facing layer on each side, such as spiral-wound, grooved-metal, and corrugated-metal gaskets, offer not only vastly improved resistance to radial shear but also enhanced sealability, and should be considered as replacements.

(d) Double-jacketed gaskets that incorporate flexible graphite facings into the design, such as the 3-ply corrugated-metal-style gasket with flexible graphite layer on each face of the gasket and with a corrugated-metal filler element, have been found to also provide improved elastic recovery characteristics and are suitable for broad service applications. Field application of graphite tape to conventional double-jacketed gaskets is not recommended and is not as effective as purchasing a gasket with graphite facings specified as part of the inherent gasket design.

(e) Check adequacy of gasket stress under the anticipated or specified bolt prestress.

(f) Gasket Width Selection — Normally use 16 mm ( $\frac{5}{8}$  in.) or wider gaskets. Use widths in the range of 25 mm to 38 mm (1.0 in. to 1.5 in.).

#### P-4.5.2 Gasket Location and Contact Surface

(a) Check if gasket contact surface location is as close as practicable to the bolt circle (e.g., minimize  $h_G$  dimension) to reduce flange rotation effects at seating surface.

(b) Gasket contact surface finish should be in range of 3.2  $\mu\text{m}$  to 6.3  $\mu\text{m}$  (125  $\mu\text{in.}$  to 250  $\mu\text{in.}$ ) for most nonpiping applications. Follow ASME B16.5 for piping flange finishes.

(c) Radial scratches deeper than the surface finish should be repaired. (Refer to Appendix D.)

(d) The use of nubbins is not generally accepted good engineering practice regardless of gasket type. Nubbins should be removed if differential radial movement of flanges occurs or is evidenced by inspection of facing surfaces.

(e) The use of male/female or tongue and groove facing to ensure proper gasket centering avoids workmanship issues.

### P-4.6 Flange Type Selection Considerations

#### P-4.6.1 Tapered Hub Type Flange (See Fig. P-1)

(a) Provides most favorable transition of stress through the tapered hub from the flange thickness to the shell thickness, a consideration favorable for services for which fatigue and brittle fracture avoidance are governing design requirements.

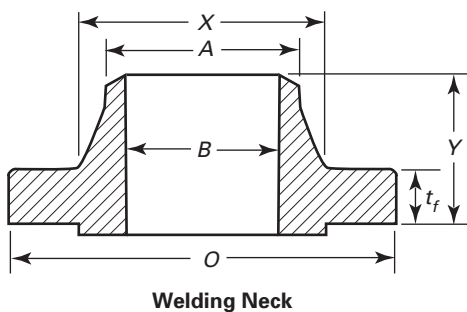
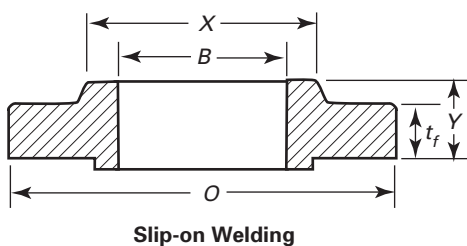
**Fig. P-1 Tapered Hub Type Flange****Fig. P-2 Slip-on Type Flange**

(b) Allows butt-welded attachment to the shell (Category C location).

(c) Allows radiographic examination of the Category C butt joint.

(d) Provides the most flange rigidity for a given flange thickness.

(e) Suitable for lethal service application.

#### **P-4.6.2 Slip-On Type Flanges (See Fig. P-2)**

(a) Not to be used for lethal service application (Section VIII, Division 1 Code requirement).

(b) Is double fillet welded to shell, thereby limiting the nondestructive examination to either MT or PT.

(c) The abrupt transition of stress from the flange (or flange hub) thickness to the shell via a fillet weld is not favorable to services for which fatigue and brittle fracture avoidance are governing design requirements.

(d) Pocket formed by face welds in a companion joint may create a liquid pool and unequal thermal stresses with resultant temporary leakage during heat-up cycle.

(e) Good practices that have evolved over time regarding the use of slip-on type flanges are to

(1) limit use to design temperatures not exceeding 343°C (650°F).

(2) limit use of carbon or low-alloy steel flanges to solid high-alloy shells to design temperatures no higher than 232°C (450°F), unless a higher temperature is justified by a complete stress analysis and accepted by the user.

(3) provide small [3 mm ( $\frac{1}{8}$  in.) diameter] vent through hub prior to welding both sides.

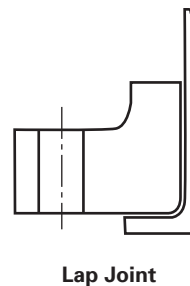
**Fig. P-3 Lap Joint Flange**

(4) avoid for services subject to moderate corrosion such as to require a corrosion allowance in excess of 1.5 mm ( $\frac{1}{16}$  in.); consider face-weld leakage and resultant hidden corrosion in crevice between flange I.D. and shell.

(5) avoid use in hot hydrogen service [defined for carbon steel as a hydrogen partial pressure exceeding 100 psia with a corresponding coincident temperature exceeding 200°C (400°F)], or other suitable company- or industry-defined hydrogen service limits.

#### **P-4.6.3 Lap Joint Flange (See Fig. P-3)**

(a) Allows use of high strength, carbon, or low-alloy steel flange material in services where expensive high-alloy pressure-boundary materials are required.

(b) Allows use of closely matching coefficients of expansion of flange materials as described above with high-strength bolting such as SA-193-B7, SA-193-B16, SB-637 (Alloy N07718), etc.

(c) Superior flange style when the joint will be subjected to rapid heat-up/cool-down temperature cycles. This is because lap joint flanges do not experience the discontinuity forces and moments created during a thermal cycle in the tapered hub-type flange which result in an unwanted flange rotation cycle. Additionally, the lap-joint flange is not in intimate contact with the service fluid and hence the heating/cooling rate of the flange assembly is retarded relative to service-fluid changes, thereby minimizing the unwanted temperature differentials between the flange and bolts.

(d) Suitable for lethal service application provided the Category C joint for lap joint stub end meets the requirement of para. UW-2 of the Section VIII, Division 1 Code.

**P-4.6.4 Use of Lap Joint Flanges.** Good practices that have evolved over time regarding the use of lap joint flanges are to

(a) require a finished lap ring thickness to be a minimum of 5 mm ( $\frac{3}{16}$  in.) greater than the nominal wall thickness of the shell.

(b) require that the laps be machined front and back as required to provide parallel surfaces and surfaces normal to the axis of the shell after all fabrication is complete.

(c) provide lap type flange-to-shell clearance of 3 mm ( $\frac{1}{8}$  in.) for nominal diameters up to and including 1 000 mm (40 in.) and 5 mm ( $\frac{3}{16}$  in.) for larger nominal diameters.

(d) Configure the gasket/lap/flange design so that the gasket load reaction on the lap (defined as  $G$  in Appendix 2 of Section VIII, Division 1) is as close as practicable to being coincident with the reaction of the flange against the back of the lap (taken as the midpoint of contact between the flange and lap).

Recommended radial lap widths are as follows:

Nozzle/Vessel O.D., mm (in.)	Radial Lap Width, mm (in.)
O.D. $\leq$ 457 (18)	25 (1.00)
457 (18) < O.D. $\leq$ 914 (36)	38 (1.50)
914 (36) < O.D. $\leq$ 1 523 (60)	45 (1.75)
O.D. > 1 523 (60)	50 (2.00)

GENERAL NOTES:

- (a) Radial lap width is measured from the toe of the lap-to-shell attachment weld to the outer edge of the lap ring.
- (b) Provide a minimum of four lugs on the shell for each lap joint flange to permit the joint to be pried apart for removing and replacing the gasket. The lugs for the lowermost flange in a joint for which the flange ring is in a horizontal plane will also support the flange when the joint is disassembled.

## P-5 Leakage Problems and Potential Solutions

This section provides a series of diagnostic tables with each dedicated to a specific type of leak event. These are

*LHT*: Leak during hydro-test (see Table P-1)

*LIO*: Leak during heat-up or initial operation (see Table P-2)

*LCU*: Leak corresponding to thermal or pressure upset (see Table P-3)

*LTO*: Leak after several months operation — piping (see Table P-4)

*LDS*: Leak during shut down (see Table P-5)

## P-6 REFERENCES

[1] Koves, W. J., "Design for Leakage in Flange Joints Under External Loads," ASME PVP Proceedings, Paper PVP2005-71254, July 2005

[2] Payne, J. R., "On The Operating Tightness of B16.5 Flanged Joints," ASME PVP Proceedings, Paper PVP2008-61561, July 2008

[3] Bickford, J. H., "An Introduction to the Design and Behavior of Bolted Joints," Chapter 19, CRC Press, 1995

**Table P-1 Leak During Hydro-Test (LHT)**

Telltale Signs	Possible Causes	Potential Solutions
Some bolts loose or near loose bolts and/or gap variation	Improper assembly	Use improved assembly procedure and qualified assemblers. See section 11 and Appendix A.
Gap variation, excessive torque for bolts mostly on one side	Excessive misalignment	Correct alignment to specification. See section 5 and Appendix E.
Excessive torque required for some (or all) bolts, some loose or near loose washers	Incorrect bolt-nut class, damaged threads, yielded or deformed bolts	Replace all bolts/nuts to proper specification and class. See para. 4(c) and Appendix N.
Excessive torque required for some (or all) bolts, some loose or near loose washers	Some bolts galled or galling under nuts	(a) Replace all bolts. Consider different bolt or nut material (e.g., avoid stainless nuts on stainless bolts or increase hardness difference between them to exceed 50 HBW) (b) Consider through-hardened washers. See Appendix M. (c) Review lubricant selection and lubrication practices. See section 7.
Gasket compressed unevenly around circumference or crimped between flange facings	Gasket shifted off flange face (not centered)	(a) Reassemble joint with emphasis on gasket location. See section 6. (b) Use improved assembly procedure and qualified assemblers. See section 11 and Appendix A.
Spiral windings are buckled inward or variation in gasket thickness is excessive around gasket perimeter	Gasket unevenly loaded	(a) Consider inner gage ring. (b) Consider buckle-resistant gasket type. (c) Improve gap measurement technique. See para. 11.3. (d) Increase bolt load in smaller increments and use more pattern (noncircular) passes initially. (e) Use improved assembly procedure and qualified assemblers. See section 11 and Appendix A.
Facing damage from weld spatter, tool dings, etc., confirmed by inspection	Damage possibly not noted in previous inspection or during assembly	(a) Remachine to specification. See Appendix C. (b) Improve inspection procedures, technique. See section 4.
Flange facing damage from excessive corrosion by highly corrosive media, confirmed by inspection	Damage possibly not noted in previous inspection	(a) Remachine to specification. See Appendices C and D and ASME PCC-2, Article 3.5. (b) Improve inspection procedures, technique. See section 4.
Flange ring warped or bent out of plane, confirmed by accurate measurements	Damage not noted in previous inspection	(a) Remachine to specification. See Appendices C and D and ASME PCC-2, Article 3.5. (b) Improve inspection procedures, technique. See section 4.



**Table P-2 Leak During Heat-Up or Initial Operation (LIO)**

Telltale Signs	Possible Cause	Potential Solutions
Bolts are not tight on inspection	Bolt load loss due to excessive initial gasket creep during heat-up	<ul style="list-style-type: none"> <li>(a) Increase initial bolt load. See Appendix 2 of Section VIII, Division 1.</li> <li>(b) Consider hot torque (if safe) during warm-up.</li> <li>(c) Increase joint flexibility by increasing effective bolt length (see para. 8.2.1) considering bolt extension collars or conical spring washers that are clearly identified as such.</li> <li>(d) Use gasket with reduced relaxation properties.</li> </ul>
Leakage stops once operation is steady state	Loss of bolt load due to excessive transient differential component temperature	<ul style="list-style-type: none"> <li>(a) Increase assembly bolt load.</li> <li>(b) Increase gasket width.</li> <li>(c) Increase joint flexibility by increasing effective bolt length (see para. 8.2.1) considering bolt extension collars or conical spring washers that are clearly identified as such.</li> <li>(d) Perform thermal-structural analysis to evaluate transient flange/bolt deformations as means to discover further remedial actions.</li> <li>(e) Consider replacing flanges with lap-type flanges as a means to reduce flange bolt differential expansion.</li> </ul>
Gap variation, some bolts loose or near loose bolts	Improper assembly	See same item in LHT
Excessive torque required for some (or all) bolts, some loose or near loose washers, gap variation	Some bolts galled or galling under nuts	See same item in LHT
Spring hangers incorrect, support lift-off, incorrectly placed restraints	Improper pipe support or restraint causing excessive bending moment	<ul style="list-style-type: none"> <li>(a) Check support, restraint system against design.</li> <li>(b) Analyze as installed piping system thermal and weight response with emphasis on bending moment at flanged joints.</li> <li>(c) Correct any deficiencies.</li> </ul>
Gasket not compressed in one section or crimped between flange facings	Gasket shifted off flange face (not centered)	See same item in LHT
Spiral windings are buckled in or variation in gasket thickness is excessive around gasket perimeter	Gasket unevenly loaded	See same item in LHT
Spiral windings are buckled	Poor gasket selection or design	<ul style="list-style-type: none"> <li>(a) Consider inner gage ring.</li> <li>(b) Use another, less soft, gasket style.</li> <li>(c) Consider buckle-resistant gasket type.</li> </ul>

**Table P-3 Leak Corresponding to Thermal or Pressure Upset (LCU)**

Telltale Signs	Possible Cause	Potential Solutions
Leakage stops or reduces once operation returns to steady state	Loss of bolt load due to process thermal (or pressure) transients	<ul style="list-style-type: none"> <li>(a) Increase gasket width.</li> <li>(b) Increase assembly bolt load.</li> <li>(c) Increase joint flexibility by increasing effective bolt length (see para. 8.2.1) considering bolt extension collars or conical spring washers that are clearly identified as such.</li> <li>(d) Consider operational changes that slow heat or cool rates, or reduce thermal swings.</li> <li>(e) Consider replacing flanges with lap-type flanges.</li> </ul>
Leakage corresponds to external event and generally stops on return to steady state	Sudden environmental change such as rain deluge	<ul style="list-style-type: none"> <li>(a) Increase assembly bolt load.</li> <li>(b) Consider external shielding.</li> </ul>

**Table P-4 Leak After Long Term (Months) of Operation (LTO)**

Telltale Signs	Possible Cause	Potential Solutions
Gasket structure/filler missing or no longer flexible or compliant	Gasket chemical degradation (chemical decomposition, oxidation, etc.)	Change gasket type.
Spring hangers incorrect, support lift-off, incorrectly placed restraints	Improper pipe support or restraint	See same item in LIO.
Bolts are not tight on inspection	Bolt load loss due to long term gasket creep	See same item in LIO.
Bolts not tight on inspection, obvious gasket deterioration, gasket structure no longer sound	Physical gasket degradation, gasket unsuitable for operating temperature	Replace gasket with a type suitable for operating conditions.
Gasket structure no longer sound (double jacket broken or windings buckled), marks on gasket surface corresponding to radial flange face movement	Gasket physical degradation due to flange differential radial movement	<ul style="list-style-type: none"> <li>(a) Remove all flange face nubbins.</li> <li>(b) Replace gasket with a type capable of taking radial shear and greater abrasion such as the first three types listed in Appendix C.</li> </ul>

**Table P-5 Leak During Shutdown (LDS)**

Telltale Signs	Possible Cause	Potential Solutions
Bolts are not tight on inspection	Bolt load loss due to long term gasket creep together with differential component cooling	(a) Increase initial bolt load. (b) Consider hot torque (if safe). (c) Consider different gasket type more suitable for operating conditions.
Bolts not tight on inspection, obvious gasket deterioration, gasket structure no longer sound	Physical gasket degradation, gasket unsuitable for operating temperature	Replace gasket with a type suitable for operating conditions.
Bolts not tight on inspection, obvious gasket deterioration, gasket structure no longer sound (double jacket broken or windings buckled), marks on gasket surface corresponding to radial flange face movement	Physical gasket degradation and loss of bolt load due to flange differential radial movement	(a) Remove any flange face nubbins. (b) Replace gasket with a type capable of taking radial shear such as the first three types listed in Appendix C.

INTENTIONALLY LEFT BLANK

## ASME Services

ASME is committed to developing and delivering technical information. At ASME's Customer Care, we make every effort to answer your questions and expedite your orders. Our representatives are ready to assist you in the following areas:

ASME Press  
*Codes & Standards*  
Credit Card Orders  
IMEchE Publications  
Meetings & Conferences  
Member Dues Status

Member Services & Benefits  
Other ASME Programs  
Payment Inquiries  
Professional Development  
Short Courses  
Publications

Public Information  
Self-Study Courses  
Shipping Information  
Subscriptions/Journals/Magazines  
Symposia Volumes  
Technical Papers

### How can you reach us? It's easier than ever!

There are four options for making inquiries\* or placing orders. Simply mail, phone, fax, or E-mail us and a Customer Care representative will handle your request.

*Mail*  
**ASME**  
22 Law Drive, Box 2900  
Fairfield, New Jersey  
07007-2900

*Call Toll Free*  
**US & Canada:** 800-THE-ASME  
(800-843-2763)  
**Mexico:** 95-800-THE-ASME  
(95-800-843-2763)  
**Universal:** 973-882-1167

*Fax—24 hours*  
973-882-1717  
973-882-5155

*E-Mail—24 hours*  
customer care@asme.org

\* Customer Care staff are not permitted to answer inquiries about the technical content of this code or standard. Information as to whether or not technical inquiries are issued to this code or standard is shown on the copyright page. All technical inquiries must be submitted in writing to the staff secretary. Additional procedures for inquiries may be listed within.

INTENTIONALLY LEFT BLANK

INTENTIONALLY LEFT BLANK

# ASME PCC-1-2013

ISBN 978-0-7918-6890-4



9 780791 868904



A15013